

Audi Symphony I to RNS-E Install Guide

Version 2.1

Prepared By:



Contributing Editor:
TeddyBGame

Symbol Glossary



A warning that should receive strict attention



Emphasizes a wiring connection to be made



Additional information on topic but not critical to the installation



Warning - Disclaimer

- **The installer shall indemnify the author and editors for any claims or liability arising from the vehicle modifications described in this document.**
- **To follow this guide requires alterations to the electrical system of the vehicle.**
- **Read and understand the entire document before beginning work.**
- **Armrest telephone handsets will no longer be operational as a result.**
- **Disconnect the negative battery terminal before altering vehicle electronics.**

Preface

I have completed the installation of a RNS-E navigation headunit and OEM satellite radio tuner into my 2001 A6. This document will be of most use to owners of a 2000-2001 C5 A6 or B5 A4/S4/RS4 and involves the replacement of the original Symphony I headunit.



For instructions on how to upgrade to the RNS-E from an existing Symphony II headunit in a 2002-2004 A6/S6/RS6 or 2002-2005 allroad, please see these two sets of excellent instructions instead of this document:

- Justin's RNS-E into a 2003 allroad here: <http://audi.ogdenlabs.com>
- Nene's RNS-E into a 2003 RS6 here: www.htms.org/rnse.html

The RNS-E works almost perfectly in the 2000-2001 A6. One issue that has yet to be resolved is the infamous "Clock problem". The RNS-E gets the time and date information from the instrument cluster. When a navigation route is programmed, the RNS-E gives an estimated time of arrival (ETA). The problem is that the time and date signals from the cluster are not completely understood. This results in an error in the RNS-E internal clock. Since this clock is wrong, the ETA given during route guidance is also wrong. If the RNS-E is loaded with the latest US firmware (internal software), the clock is also shown in the bottom center of the screen at all times. This clock display will also be wrong most of the time. Many users are in the process of troubleshooting this problem but a solution has yet to be found.

This document is prepared as a step-by-step guide and will follow the outline on the next page. No one step is particularly difficult, but as a whole it can seem overwhelming. The outline may reinforce that feeling at first glance. In this case, the reader is urged to read and understand each section individually. The work in each section can be performed independently of the other sections, except that the completion of Section 1 is a prerequisite to the work demonstrated in the remaining sections.



A complete installation of the RNS-E requires all steps in Section 1 to be performed. Do not install the headunit without connecting to CANbus or without having access to VAG-COM or other means to code the control module.

Note from the Author

Thanks to the www.navplus.us community as a whole. This is one of the best automotive based forums to which I have ever had the pleasure of contributing.

Special thanks to users TeddyBGame and Proxus for putting together the deal that enabled me to obtain the RNS-E navigation headunit. Ted has extensive knowledge of Audi audio and navigation systems and we have collaborated on many projects. Proxus was a great seller to deal with and worked with me on some issues with my navigation DVD even after the sale.

Because of some past inquiries, I would like to say that donations are gladly accepted but not expected. Many hours of research and labor produced this document but I consider it to be freeware. If you paid money to gain access to this document, you were robbed.

If you have any questions or comments, big or small, please feel free to email me, lee@nsxjr.com.

The most recent version of this document can be downloaded from the web at www.nsxjr.com

Section 1	RNS-E Navigation Headunit	Page 1
1.1	Instrument Cluster	
1.1.1	Connecting to CANbus	
1.1.2	Mounting the GPS Antenna	
1.2	Reverse Wire	
1.3	Headunit Installation	
1.3.1	Connecting to CANbus	
1.3.2	Plug-and-Play Wiring Harness	
1.3.3	Radio Antenna Adapter	
1.3.4	Entering the Security PIN Code	
1.4	Control Module Coding (VAG-COM)	
Section 2	Satellite Radio Module	Page 19
2.1	The Basics: SAT Radio Tuner Wiring Info	
2.2	Power Wires	
2.3	Audio Wires	
2.4	Data Wires	
2.5	Antenna Wires	
2.6	Completion	
Section 3	Multifunction Steering Wheel	Page 26
3.1	MFSW Control Unit Installation	
3.2	Control Module Coding (VAG-COM)	
Section 4	Bluetooth Telephone Module	Page 29
4.1	Custom Wiring Harness	
4.2	Connecting the K-line	
4.3	Control Module Coding (VAG-COM)	
Section 5	TV Tuner Module or A/V Interface (future project)	

List of Appendices

Appendix A	Parts List
Appendix B	RNS-E Engineering Mode
Appendix C	SAT Radio Diagnostics
Appendix D	Symphony I to RNS-E Wiring Diagram
Appendix E	SAT Tuner Wiring Diagram
Appendix F	Trunk Trim Removal
Appendix G	BOSE® Amplifier Pinouts
Appendix H	Climate Control Faceplate
Appendix J	Screen Shot Mode
Appendix K	Bluetooth Module Operation via Steering Wheel

Section 1 RNS-E Navigation Headunit

The installation of the RNS-E Navigation unit into a 2000-2001 A6 is a multi-step process. The main obstacle to overcome for this installation is that the original Symphony I radio is not CANbus (*C*ontroller *A*rea *N*etwork) enabled. The vehicle has many CANbus systems, from engine management, to transmission control, to the one of interest here called “infotainment”. These are all separate networks, and the “infotainment” communication network is the one that helps all the radio, telephone, navigation, telematics, etc in a vehicle communicate with one another in an efficient manner. All of these different items are connected to the CANbus like a computer network and they all communicate via two wires, CAN H and CAN L. The Symphony I radio shows CAN H and CAN L on the wiring label, but it is not wired to function via CANbus. The CANbus network is available in the vehicle if the clock in the tachometer dial is digital. If the vehicle has an analog clock then stop here, the wiring in this document will not apply to that vehicle.

 *If the CD-based navigation system is installed in the trunk, the CANbus wiring will be present. These wires will need to be removed and taped out of the way during the installation process.*



**Have all Radio Security Codes in hand before disconnecting the battery.
Eject the CD from the Symphony headunit before disconnecting the battery.
Do not turn the ignition switch on while the instrument cluster is removed.**

1.1 Instrument Cluster

The first tasks to complete are behind the instrument cluster. Cover the top of the steering wheel column with a shop towel or painter’s tape to prevent scratching when the cluster is removed.

 *Some images in Section 1 are ©2004 -Ted Basile and are used with express written permission.*



I highly recommend protecting your steering wheel and column by putting down blue painters’ tape. The two bottom screws of the instrument cluster can dig into your steering wheel column as you are removing it.

© Copyright – Ted Basile (teddybgame@hotmail.com)

Update d: 12/27/2005

Remove the center trim piece (1) between the steering wheel column and instrument cluster by pulling straight out.

(i) The picture shows the steering wheel removed. It is not necessary to remove the steering wheel for any part of this installation.

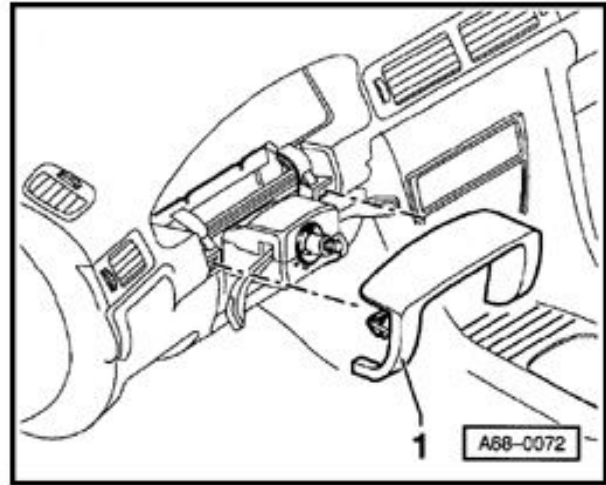

Remove the driver's side knee panel and set it out of the way. See the picture below.

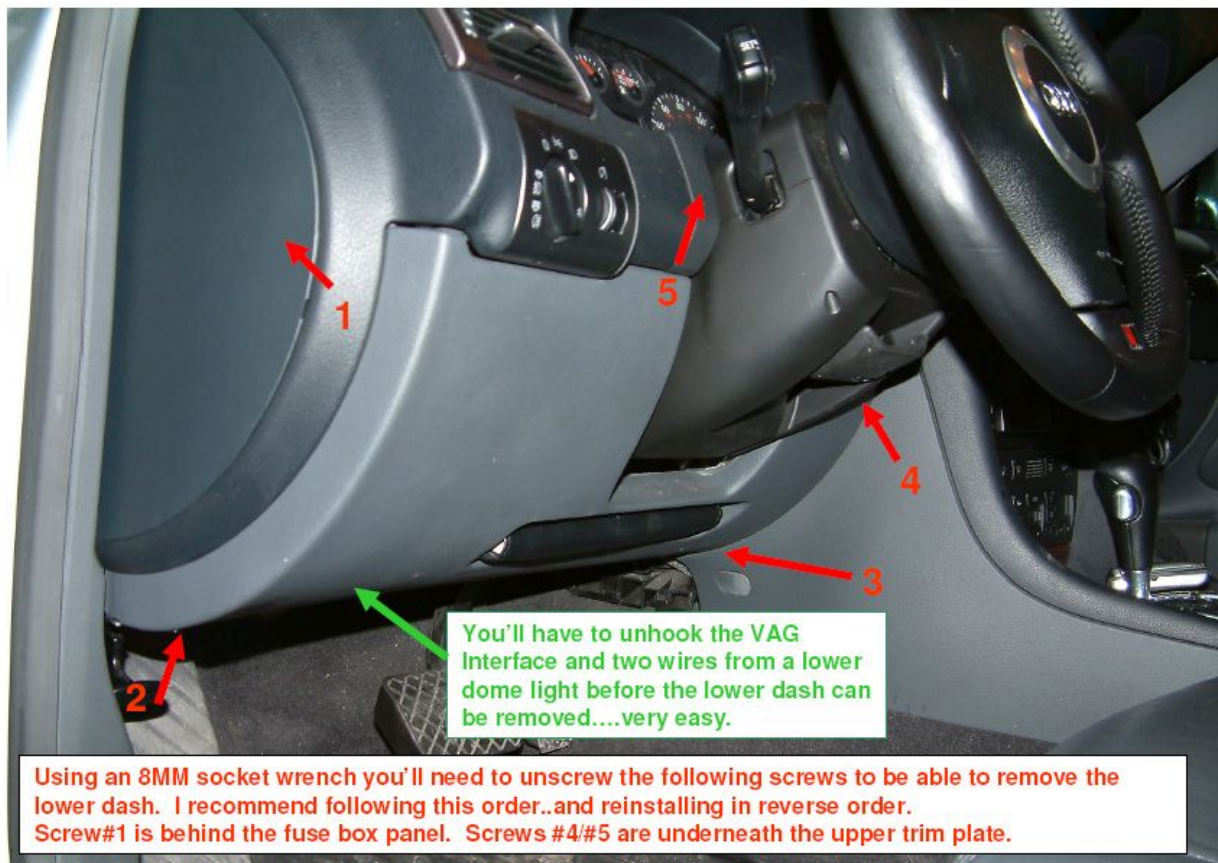

© Copyright – Ted Basile (teddybgame@hotmail.com)

Updated: 7/19/2004

Remove the two Phillips screws holding the bottom of the instrument cluster. These are likely to be extremely tight. Use the proper size Phillips screwdriver. Reach up under the dash and push the instrument cluster out from the rear. When the cluster is loose, remove it by pulling the left side out first, unplugging the blue connector on the left rear, then the grey connector in the middle, then the green connector on the right end. Each of these plugs has a small purple clamp that holds it in place. Simply lift this purple clamp up and the plug will remove itself from the cluster. See next illustration.



Remove these two philips head screws. FYI - They are on tight, so make sure you have the correct size Phillips head; you don't want to strip that screw head or you'll need to drill them out. ☺

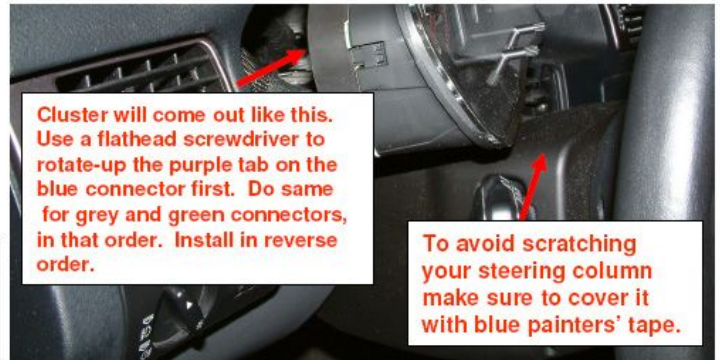

Cluster will come out like this. Use a flathead screwdriver to rotate-up the purple tab on the blue connector first. Do same for grey and green connectors, in that order. Install in reverse order.

To avoid scratching your steering column make sure to cover it with blue painters' tape.

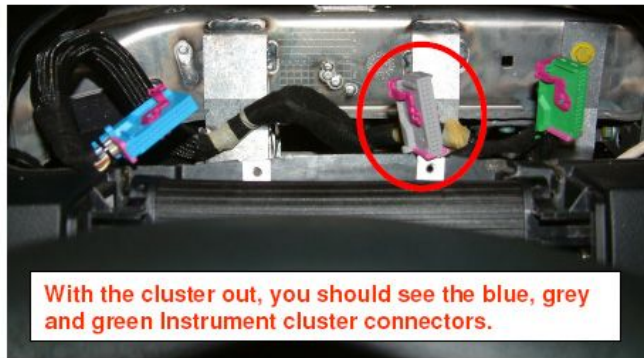

With the cluster out, you should see the blue, grey and green Instrument cluster connectors.

© Copyright – Ted Basile (teddybgame@hotmail.com)

Updated: 12/27/2005



To remove the instrument cluster screws, try tightening the screw first just to break it loose. The screw has a very fine thread pitch meaning the screw will not actually tighten much by being turned clockwise. Also, use an offset screwdriver for better torque. This method has worked for me numerous times.

Remove the Symphony I headunit.

Insert the four radio removal tools as shown. Cover the top of the climate control unit with painter's tape to prevent accidental scratches while removing and installing the radio.

Pull the headunit straight out without pulling on the radio removal tools. If necessary, push the radio out from behind by reaching around under the driver's side dash in the area revealed by removing the knee panel. Alternatively, place as many fingers as possible in the cassette slot, wiggle and pull.

Once the radio is out, unplug the four wiring harnesses, the two antenna connectors, and the brown single wire connector. Remove the radio keys from the face by pressing in the locking tab and pulling the key straight out. This is illustrated in the picture to the right. Set the Symphony I radio aside.

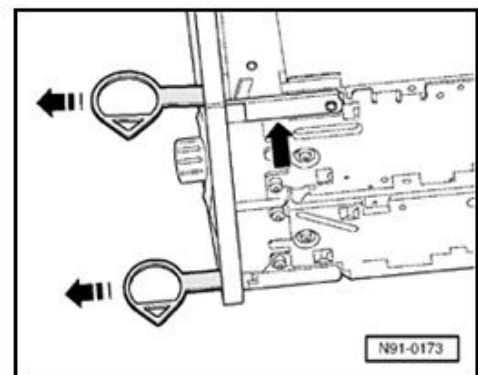
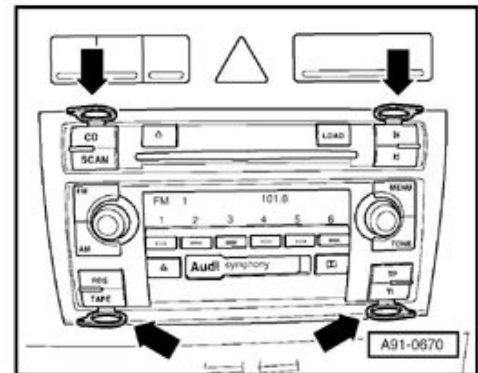

1.1.1 Connecting to CANbus

This step changes CLK and DATA wires that run from the cluster to the radio to CAN H and CAN L. This also accomplishes is the reassignment of the correct pins on the steering wheel control unit to be on the CAN network for proper operation. Refer to **Appendix D** for diagrams of the wiring changes outlined in Section 1.

-  *The steering wheel control module installation is covered in Section 3.
The existing control unit may be left in place with no ill-effects but will not be operational.*

The grey instrument cluster connector must be dismantled to change the wiring. This connector is called T32c. Slide a little purple clamp off the bottom, remove the cable tie from the bottom and then slide the grey cover off the top of the connector. Rewire the pins as shown below.



- ➔ Remove the CLK wire from Pin 12 of T32c and reinstall into Pin 5 (CAN H) of T32c.
- ➔ Remove the DATA wire from Pin 13 of T32c and reinstall into Pin 6 (CAN L) of T32c.

Reinstall the grey cover, purple bottom clip and cable tie onto the connector T32c.

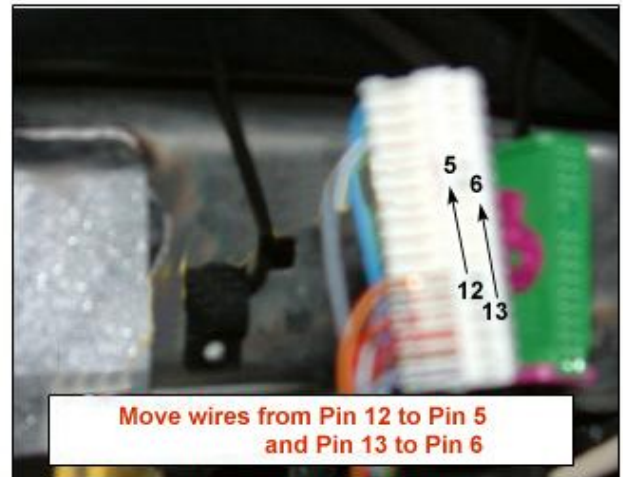

© Copyright – Ted Basile (teddybgame@hotmail.com)

Updated: 7/19/2004

1.1.2 Mounting the GPS Antenna

While the instrument cluster is removed, install the GPS Antenna as shown in the picture below. Extend the antenna wire from this location to the area behind the headunit. This is a proven installation location for almost every Audi vehicle. It will likely be necessary to fish the wire from the cluster area to the headunit area by accessing the area under the dash on the driver's side.

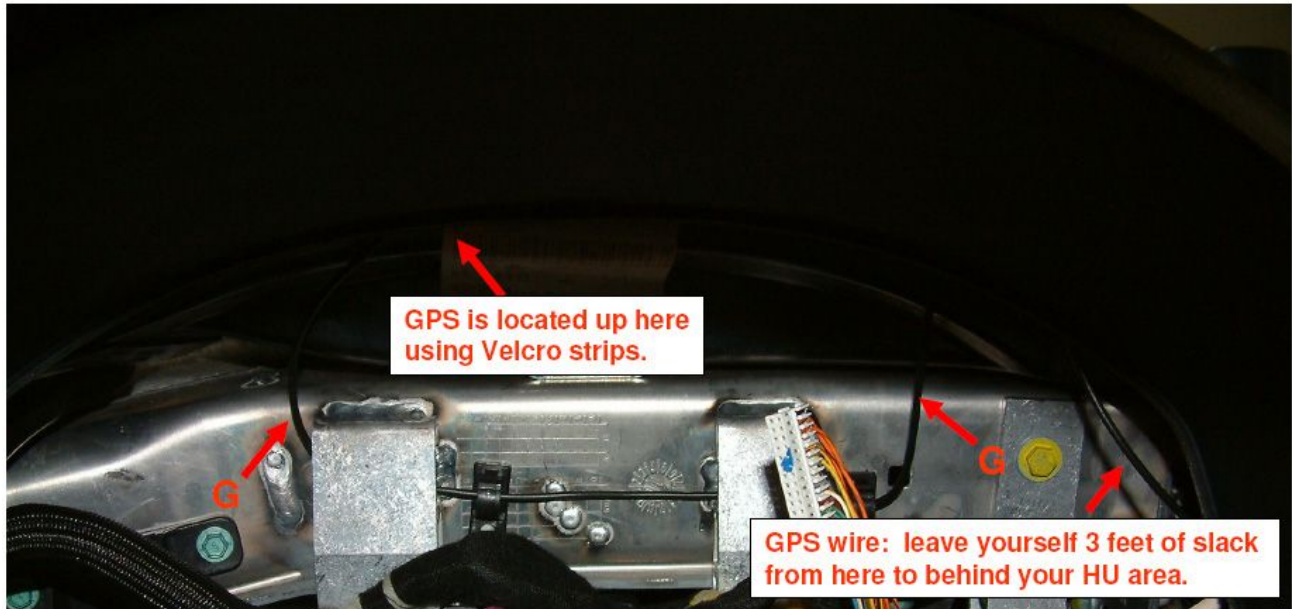

Using 2" Velcro strips, I attached my GPS antenna up inside the dash area (above the inst. cluster). You can't see it from this location, but when you have the cluster out, you will notice a little "cubby hole" area where you can insert the GPS. I put the Velcro strips down first, then wrapped my GPS in Velcro; it's in there pretty tight. Make sure the antenna is laying horizontally (or flat). As for reception, I average 5 or 6 GPS satellites received most of the time (a minimum of 3 is needed). As for the remaining wire, you can also wrap it in Velcro and stuff in that same cubby area. I decided to run the GPS wire in between these metal support pieces (not required for everyone else).

© Copyright – Ted Basile (teddybgame@hotmail.com)

Updated: 12/27/2005

Reinstall all connectors onto the instrument cluster, making sure the purple clamps lock into place.

Reinstall the instrument cluster by gently pushing back into place and tightening the two screws.



If desired, the instrument cluster screws can be replaced with similarly threaded hex-head screws. This type of screw will be easier to remove if the instrument cluster needs to be serviced in the future.

1.2 Reverse Wire

The RNS-E installation into the A6 requires that a separate connection for the reverse wire be made. This wire permits the RNS-E to know when the vehicle is in reverse gear so that it will move the indicator correctly on the map. Without this wire, the RNS-E will move the indicator forward on the map which will create a location error until the unit is able to synchronize with the GPS satellites. This sync seems to occur about once a minute while the unit is receiving at least three satellite signals.

 This subsection is not required for the installation. If not completed, the vehicle location on the map will be in error for a period of time after travelling in reverse.

Remove the left side lower A-pillar trim.

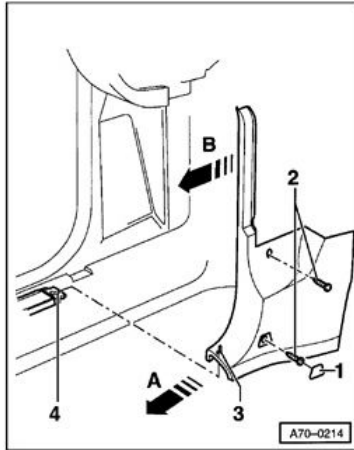

Lower A-pillar trim, removing and installing

- Pry out cover - **1** - .

- Remove screws - **2** - (2x). Tightening torque: 2.5 Nm (22 in lb)

 - Pull lower A-pillar trim in direction of arrow - **A** - until pin - **3** - can be detached from groove - **4** - .

- Pull extension of lower A-pillar trim in direction of arrow - **B** - out of retainers (2x).

Locate Connector T10f, the brown 10-pin connector in this connection station. Pin 8 in this connector is a blue/red wire that signals reverse. Tap into this wire and run the connection to the area behind the headunit. This wire indicates +12V when the vehicle is in reverse gear.



The wire must be well secured and not interfere with the steering mechanism.

Reinstall the lower A-pillar trim, the driver's side knee panel, and the upper steering column trim.

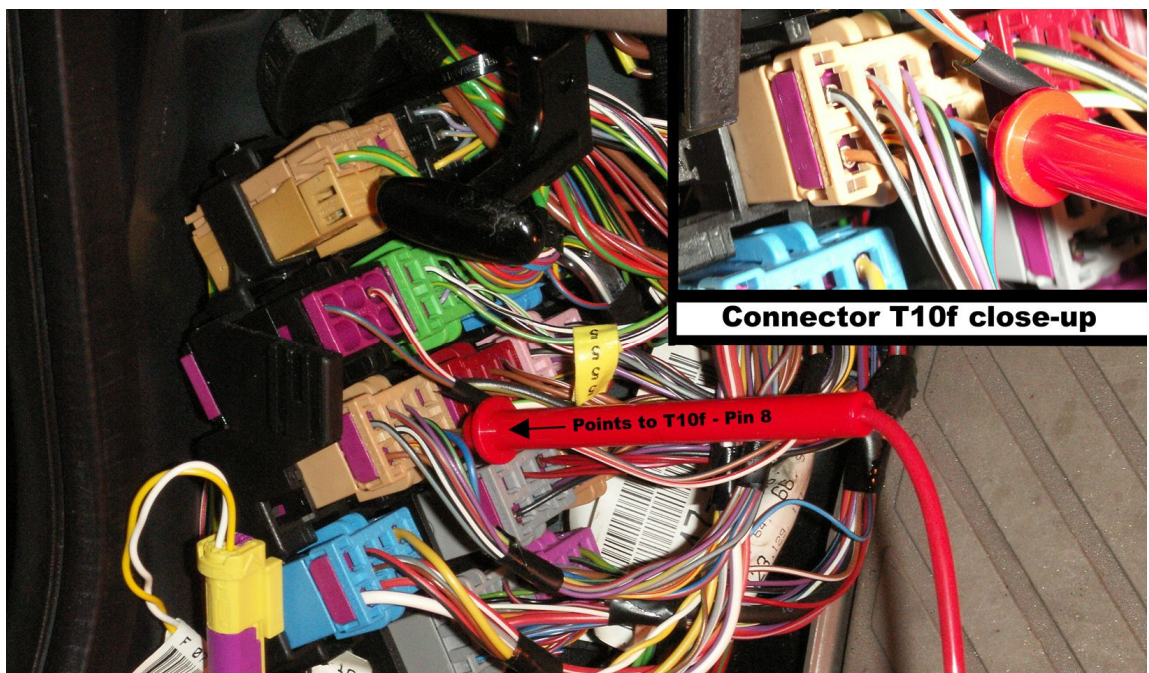

1.3 Headunit Installation

The subsections within this topic will describe how to complete the physical installation of the RNS-E headunit. To continue from this point, Sections 1.1 and 1.2 must be complete.

Before performing the work in this section, the original satin black climate control faceplate may be replaced with a faceplate from a 2002-2004 A6 to match the flat black color of the RNS-E. Since this step is not required, further information is located in **Appendix H**.

1.3.1 Connecting to CANbus

 Obtain a terminal extractor tool to make this section a snap. <http://forums.bostonaudi.org/viewtopic.php?t=3945>

In the area behind the headunit, locate the black (or multi-colored) 20-pin connector. This is officially named Connector I. The pins in this connector are smaller than all the other connectors. The purple sliding locking bar does not completely come out of this connector, but it must slide out as far as it will go before moving any wires. The vehicle may have the three colored pieces that all snap together to form one instead of the black housing. See the picture below for comparison of both types.

- ➔ Remove the CLK wire from Pin 8 of Connector I and reinstall into Pin 7 (CAN H) of Connector I.
- ➔ Remove the DATA wire from Pin 9 of Connector I and reinstall into Pin 12 (CAN L) of Connector I.

Slide the purple locking bar back into its closed position.

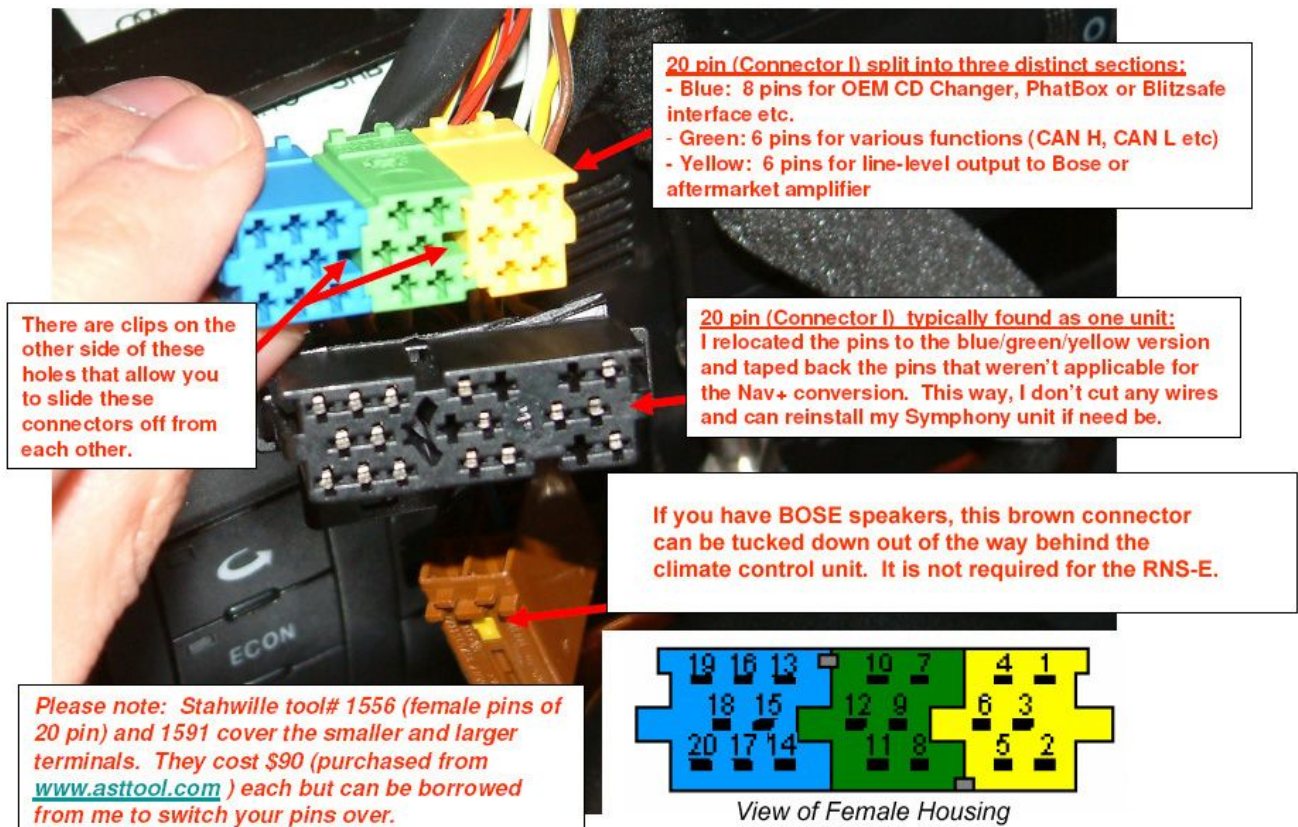

© Copyright – Ted Basile (teddybgame@hotmail.com)

Updated: 7/19/2004

1.3.2 Plug-and-Play Wiring Harness



This section describes a crucial step that is often overlooked during installation. The plug and play harness provides all electrical connections to an expensive electronic device that is likely used and carries no warranty coverage.

The plug-and-play (PNP) harness is the easiest way to connect the majority of the wiring when replacing a symphony radio. This has two ends that will be referred to as the RNS end and the vehicle end. The RNS end is the large square “Quad-lock” connector. The vehicle end has four housings that connect to the four plugs removed from the symphony radio. These PNP harnesses can be purchased for the specific vehicle requirements of Bose or Non-Bose, telephone or none, and CD changer or none. It is recommended to purchase the telephone and CD changer options even if the vehicle is not presently equipped with those modules. This will ensure flexibility for future upgrades.

➔ Verify that each wire of the PNP harness connects the proper pins on each end.

The chart on the next page lists each item and the correct pin assignments for comparison. There are pictures following the chart that detail the pin numbers listed in the chart. There are also wiring labels on the top of the RNS-E and Symphony I that list all pins with descriptions. This is an important step to ensure proper operation of the RNS-E. Many PNP harnesses are assembled with the Symphony II radios in mind, and there will be a few wiring differences compared to the Symphony I.



Reminder: This document is specific to installations replacing the Symphony I radio. For Symphony II radio replacements, there is a chart specific to that installation available on the web at www.nsxjr.com

Some connections are made outside the PNP harness, meaning it is only connected to one harness end.

- ➔ Connect RNS-E Pin B7 to ground if the vehicle is equipped with the BOSE system
- ➔ Connect RNS-E Pin C2 to the reverse wire installed in Section 1.2.
- ➔ Connect RNS-E Pin D14 to the large brown single pin connector.
- ➔ Connect vehicle Pin 10, Connector IV to chassis ground in a convenient location.

Once the PNP harness has been verified for accuracy, connect each vehicle end to the corresponding plug in the vehicle. Each connector can only be inserted one way to protect against wiring mistakes.



If the vehicle is equipped with the BOSE amplifier and speaker system, the front speaker connector can be completely removed from the PNP harness. This is RNS-E connector A to vehicle connector II.

Plug-and-Play Harness wiring chart for Symphony I to RNS-E

Description	RNS-E harness end		Vehicle harness end		
	Pin	A: Speaker Connector	Pin#	Connector	Description
	1	N.C.	N.C.		
Connector	2	Right Front (+)	3	II	RF+
not	3	Left Front (+)	5	II	LF+
necessary	4	N.C.	N.C.		
for	5	N.C.	N.C.		
BOSE	6	Right Front (-)	4	II	RF-
systems	7	Left Front (-)	6	II	LF-
	8	N.C.	N.C.		
		B. EXT Control Connector			
MOST network	1	Most Ring break	N.C.		
CDC Audio	2	CDC-NF GND	18	I	S GND
Speed signal	3	V-Signal	1	III	GALA
Battery Power out	4	U14R-2	16	I	+12V
K diagnostic	5	K-Line	3	III	K
CDC Data	6	CDC-Data out	14	I	DATA OUT
Bose ground wire	7	BOSE Pin	Ground for Bose Systems Only		
CDC Audio	8	CDC-NF L.IN	19	I	L CH
CDC Audio	9	CDC-NF R. IN	20	I	R CH
accessory power	10	U14 ST CDC	17	I	ACC
CDC Data	11	CDC -Data IN	13	I	DATA IN
CDC Data	12	CDC- Data CLK	15	I	DATA CLK
		C: EXT Control Connector			
mic for speech control	1	MIC IN (-)	N.C.		
reverse +12V	2	RFSL	Connect to Reverse Wire		
to amp	3	Line Out FL	4	I	LF
mic out to tel module	4	MIC Out (-)	N.C.		
to amp	5	Line Out RL	1	I	LR
tel module audio in	6	TEL NF IN (-)	4	IV	TEL -
mic for speech control	7	MIC IN (+)	N.C.		
to amp	8	Line Out GND	3	I	COM
to amp	9	Line Out FR	5	I	RF
mic out to tel module	10	MIC Out (+)	N.C.		
to amp	11	Line Out RR	2	I	RR
tel module audio in	12	TEL NF IN (+)	3	IV	TEL +
CDC chassis ground		Connect to Ground in convenient location	10	IV	CD GND
		D: Power Connector			
infotainment bus	9	CAN-H	7	I	CAN H
infotainment bus	10	CAN-L	12	I	CAN L
Tel Module mute	11	TEL-Mute	1	IV	MUTE
Main Ground	12	KL31	8	III	(-)
Amp turn on	13	U14 ST DSP	6	I	ACC
Alarm GND	14	DWA-GND	Connect to large brown single pin connector		
Main Power	15	KL30	7	III	(+)
Battery Power out	16	U14R-1	N.C.		



Legend

N.C.	No Connection	
NF	Niederfrequenz	English: Audio Frequency
Kl.	Klemme	English: Terminal
DWA	Diebstahl Warnanlage	English: Theft Alarm System

Plug-and-Play Harness

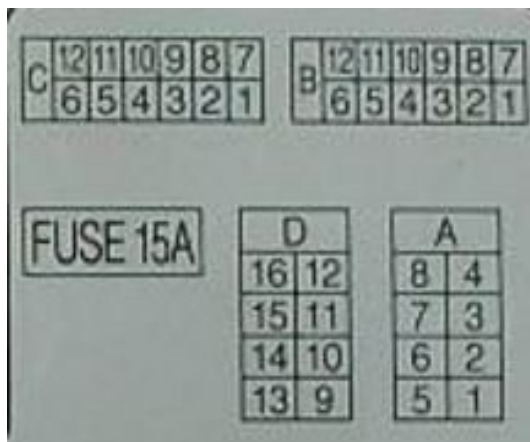
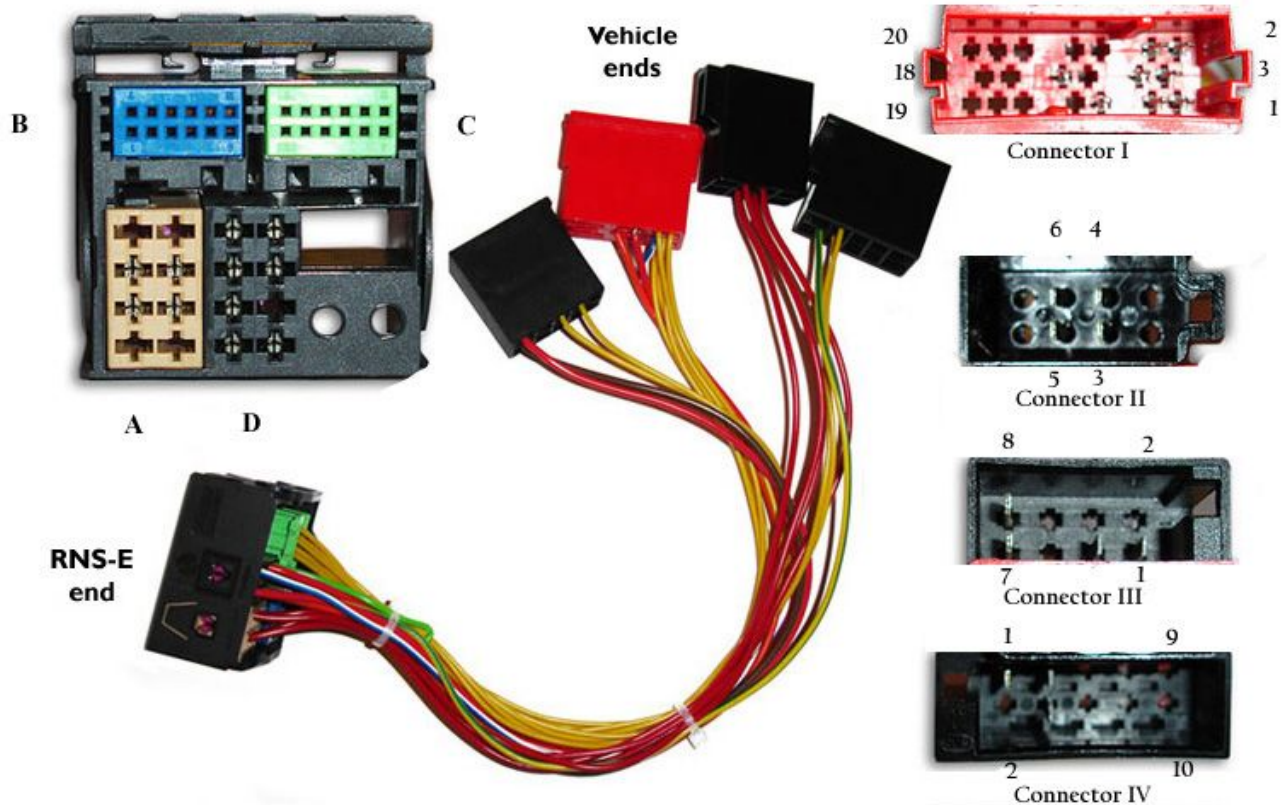

RNS-E

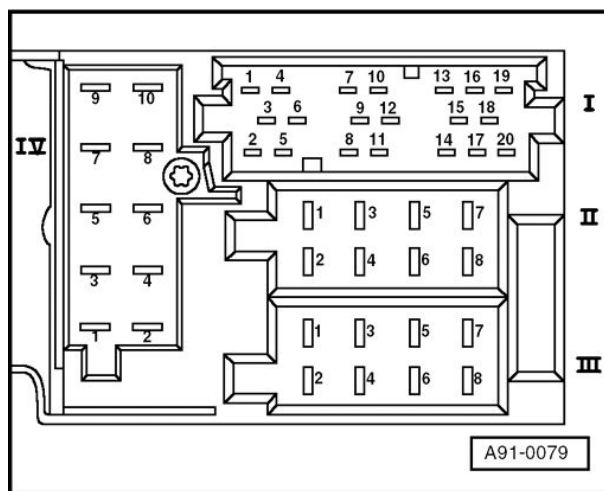

Symphony I

1.3.3 Radio Antenna Adapter

The Radio Antenna ends must also be used with an adapter harness in order to be connected to the RNS-E headunit. It is crucial to purchase the correct antenna adapter. Most antenna adapters that are supplied in package deals are used for upgrades from Symphony II radios and will not work for replacement of the Symphony I. The correct antenna adapter is shown below.

➔ Connect the two antenna leads from the vehicle to the antenna adapter.



1.3.4 Entering the Security PIN Code



**Do not continue without the Radio Security PIN Code available.
Do not press on the LCD screen while sliding the RNS-E into place.**

Connect the PNP harness, radio antenna adapter, and GPS antenna to the RNS-E unit. Slide the RNS-E into place as far as it will go, but not so far that it locks into place. Reconnect the negative battery terminal. The Security code PIN entry is not as simple as inputting the code once to unlock the unit. For some reason, the RNS-E unit needs some time to acclimate itself to the vehicle. Follow the steps below to unlock the unit. This sequence will be necessary every time the unit is disconnected from the battery for more than a few minutes.

1. Turn on the ignition. Turn on the RNS-E if it does not start with the ignition.
2. Press the “SETUP” and “RADIO” (or FM|AM) buttons for a few seconds until the unit reboots.
3. Input the PIN code. The unit will likely immediately return to the PIN entry screen.
4. If the unit accepts the PIN code, skip ahead to Section 1.4 to code the control module.
5. With the ignition still on, input the PIN code a few more times and wait 15 minutes.
6. Turn the ignition off and wait 30 minutes.
7. Repeat steps 1 through 4.

If the installation will not continue to include Satellite radio, telephone module, or A/V interface, then the RNS-E may be pushed all the way into place until the locking tabs click. In the A6 this will be tricky because extra space behind the headunit is scarce. The housings at the vehicle end of the PNP harness plugs should be tucked into the space behind the climate control unit. This can be done by holding the RNS-E as close to the opening as possible with one hand while using the other hand to tuck the housing ends down. It will take a few tries to get it right. Slide the RNS-E into place by placing fingertips near the radio removal key slots and pushing straight back. Do not push on the LCD screen. Ensure all four tabs lock into place with a popping sound.

1.4 Control Module Coding (VAG-COM)

The RNS-E and instrument cluster must be coded with VAG-COM to ensure proper operation. Connect a diagnostic cable to the vehicle and start the VAG-COM software on the computer.

i In lieu of using VAG-COM software, the vehicle can be coded at any Audi dealership. Expect to pay for this service.

i VAG-COM Release 512 is recommended.

From the Main VAG-COM screen, press “Select” under the Select Control Module area.

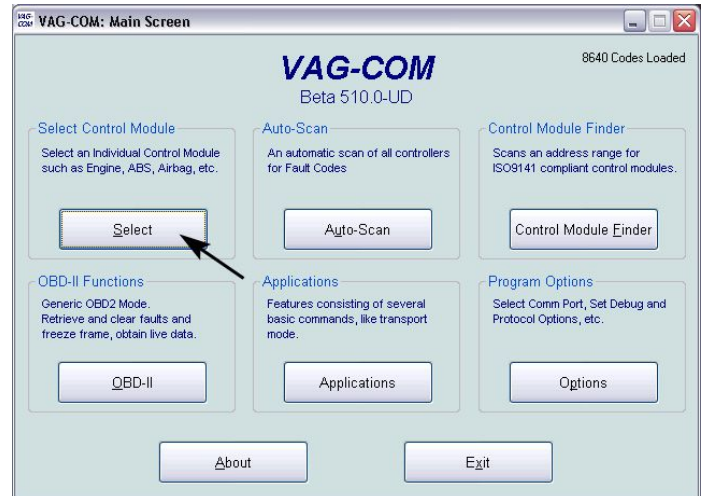

Select “37-Navigation” or “56-Radio” on the Control Module Screen. Either option will access the RNS-E for coding.



The software is now connected to the RNS-E in the “Open Controller” window. Note the Software Coding located just below the part number display. Check the chart on the next page to see what the coding means. If the coding is satisfactory, exit out of the VAG-COM software and skip the recoding instructions directly to the adaptation settings. If the control module needs to be recoded, continue with the steps below.



i My coding is 0509635, this is for: A6 with Bose, SAT radio, BT module, and Multifunction Steering Wheel.

Control Module Coding Chart for RNS-E Navigation Unit

0?xxxxx: Vehicle

- 1 - Lamborghini
- 2 - Audi A3 (8P)
- 3 - Audi A4 (8E)
- 4 - Audi A4 Cabriolet (8E)
- 5 - Audi A6 (4B)
- 6 - Audi TT (8J)

0x?xxxx: Diagnostics

- 0 - Diagnostics for front speaker active (*not Audi A4 Cabriolet*)
- 1 - Diagnostics for front speaker inactive (*only Audi A4 Cabriolet*)

0xx?xxx: Sound Characteristics

- 0 - Linear
- 1 - Audi A4 (8E)
- 2 - Audi A6 (4B)
- 3 - Audi A4 Cabriolet (8E)
- 4 - Audi TT (8J)
- 5 - Audi A3 (8P)
- 9 - Bose Soundsystem

0xxx?xx: Telephone / Telematics

- 1 - No Telephone (*supply voltage for microphone actively*)
- 2 - Telephone (*Temic - supply voltage for microphone inactively*)
- 3 - Telephone (*Cullman - supply voltage for microphone inactively*)
- 4 - Telephone (*Nokia - supply voltage for microphone inactively*)
- 5 - Telematic EU (*supply voltage for microphone inactively*)
- 6 - Telematic US (*supply voltage for microphone inactively*)
- 7 - Mobile phone preparation self-diagnostic-able with comfort operation

0xxxx?x: Options I

- 1 - No additional Tuner
- 2 - Digital-Radio
- 3 - Satellite-Radio
- 4 - Satellite- and Digital-Radio built-in

0xxxxx?: Options II

- 1 - No TV-Tuner, CD-Changer or MFSW
- 2 - TV-Tuner Only
- 3 - CD-Changer Only
- 4 - TV-Tuner und CD-Changer
- 5 - MFSW Only
- 6 - TV-Tuner and MFSW
- 7 - CD-Changer and MFSW
- 8 - All: TV-Tuner, CD-Changer and MFSW

To change the coding, press “Recode-07”



Enter the new coding desired in the “Software Coding” box.

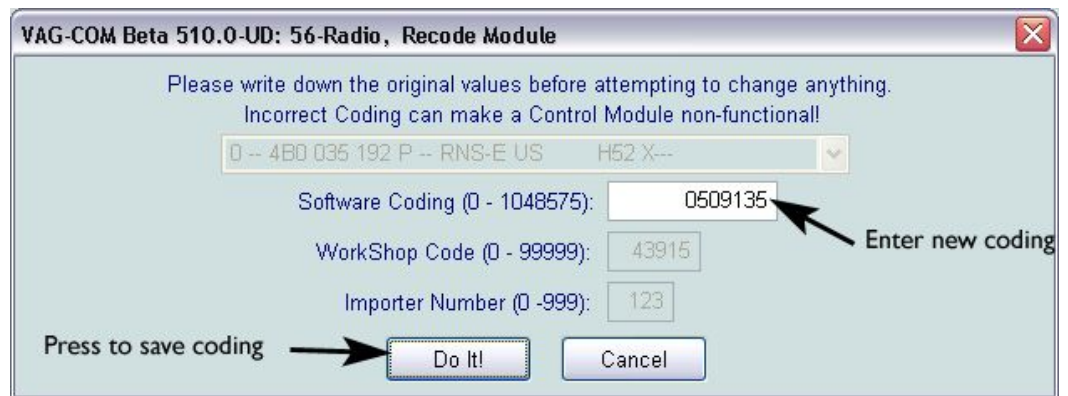

Verify that the new coding was accepted in the “Open Controller” window.



To change the adaptation values, press “Adaptation-10”



Scroll through each adaptation channel that is listed in the chart below. Enter the correct value based on the vehicle characteristics. When finished, press “Done, Go Back”. The important channels are shown in yellow highlight. The remaining channels can be set via the menu system in the RNS-E itself.

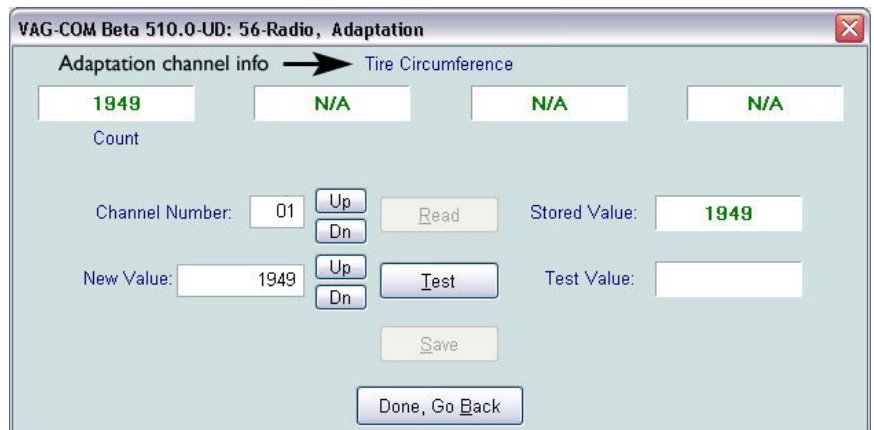

Control Module Adaptation Chart for RNS-E Navigation Unit

-> Channel 001 (Tire Circumference in mm)

Summer Tires

1790 - 145/80 R14
 1815 - 165/65 R15
 1803 - 175/60 R15
 1806 - 185/50 R16
 1935 - 195/65 R15
 1910 - 205/60 R15
 1930 - 205/55 R16
 1818 - 205/40 ZR17
 1960 - 215/55 R16
 2060 - 225/60 R16
 1930 - 225/45 R17
 2074 - 225/55 R17
 1943 - 225/40 ZR18
 1960 - 235/50 R16

Summer Tires

1964 - 235/45 R17
 1967 - 235/40 ZR18
 2065 - 245/45 R18
 2065 - 245/45 ZR18
 1940 - 255/40 R17
 1937 - 255/35 R18
 1937 - 255/35 ZR18
 2016 - 255/40 ZR18
 2016 - 255/35 ZR19
 2092 - 255/35 ZR20

Winter Tires

1775 - 155/65 R15
 1895 - 185/65 R15
 1935 - 195/65 R15
 1930 - 205/55 R16
 1960 - 215/55 R16
 2092 - 215/65 R16
 2060 - 225/60 R16
 1930 - 225/45 R17
 2070 - 225/55 R17
 1940 - 225/40 R18
 2010 - 225/45 R18
 2040 - 235/45 R18
 2114 - 235/50 R18
 1940 - 255/40 R17

-> **Channel 002 (Speed Signal)**

- 00 - self calibration which automatically selects the correct value after some kilometers.
- 08 - Audi A6 (4B)
- 43 - Audi A3 (8P)
- 45 - Audi A4 (ab MJ 2004)

-> **Channel 003 (Language Selection)**

- 0 - German
- 1 - English (UK - NOT North America)
- 2 - French
- 3 - Italian
- 5 - Spanish
- 7 - English (US - ONLY North America)

-> **Channel 005 (Video in motion switch off)**

- 0 - Switch off once moving.
- 1 - Switch off over 5 km/hr

-> **Channel 007 (Expanded Settings)**

- +01 - Distance Unit in Miles
- +02 - Speed Unit in MPH
- +04 - Time Format in 12HR
- +08 - Date Format in MM:DD:YYYY
- +16 - Repeat Voice Commands

-> **Channel 008 (GALA-Function)**

- 000 - GALA Function Switched Off
- 001 - Level 1
- 002 - Level 2
- 003 - Level 3
- 004 - Level 4
- 005 - Level 5
- 255 - GALA via microphone (BOSE audiopilot)

-> **Channel 010 (Region)**

- 0 - Northern Hemisphere
- 1 - Southern Hemisphere

-> **Channel 066 (Self Check)**

To start the self check enter a value of 1. These values are not permanent and serve only to start the tests. Thereby the following components are tested:

DVD, GPS Receiver, GPS Antenna, Gyro, Key, Internal Interface Status, Communication to the Tuner module, CAN-Bus Chip, Card Readers 1 & 2, Passive speakers, radio antenna, DSP, Microphone.

-> **Channel 067 (CD/DVD Eject)**

- 000 - Normal Status
- 001 - CD/DVD eject (value is not stored)
- 255 - Eject Button disabled (theft protection)

-> **Channel 068 (Test Picture)**

These values are not permanent and serve only to start the tests.

- 0 - No test pattern
- 1 - Test pattern Red
- 2 - Test pattern Green
- 3 - Test pattern Blue
- 4 - Test pattern White
- 5 - Test pattern Black
- 6 - Test pattern Chessboard
- 7 - Test pattern Chessboard (inverted)
- 8 - Test pattern 64 Greytones (vertical bars)
- 9 - Test pattern special

-> **Channel 069 (Display Mechanism)**

- 000 - Display closed
- 001 - Display open
- 200 - Display half open (hinderance)
- 255 - Undefined position

-> Channel 070 (Display-Brightness)

- 0 - Switched off
- 1 - 20 % Brightness
- 2 - 40 % Brightness
- 3 - 60 % Brightness
- 4 - 80 % Brightness
- 5 - 100 % Brightness

-> Channel 099 (Transport Mode)

This channel is used only on vehicles without a CAN gateway.

- 0 - Transport mode inactive
- 1 - Transport mode active

-> Channel 111 (System Reset)

When you store a value of 1 the system is reset. The controller is restarted but fault codes are not cleared.

-> Channel 114 (FM-Sender Status)

On inquiry.

-> Channel 117 (Signal Position)

Adjustment of the signal output on individual speakers.

- 0 - Fader center - Balance Center
- 1 - Fader front - Balance left
- 2 - Fader front - Balance right
- 3 - Fader rear - Balance left
- 4 - Fader rear - Balance right

-> Channel 136 (Navigation references)

Adjustment of the voice prompts related to driver position.

- 00005 - Left hand drive (USA)
- 00013 - Right hand drive (USA)
- 02632 - Right hand drive (Europe)
- 03226 - Left hand drive (Europe)

Exit out of the Adaptation screen when complete. Now is a good time to check out the Measuring Blocks. These show information on the active functions of the RNS-E. From the Open Controller screen, press "Meas. Blocks - 08"



The Measuring Blocks screen shows different groups of values that display real time readings. This is helpful because it displays all sorts of information that gives insight into the workings of the RNS-E. Scroll through the groups to display different information items.

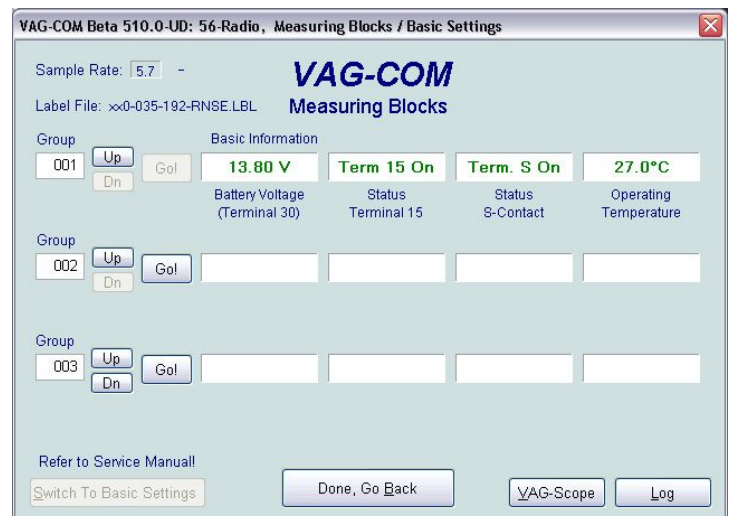

Exit back out to the Main VAG-COM screen when finished.

The last step is to get the instrument cluster adapted to recognize the radio and navigation data for use in the Driver's Information System (DIS). This is the small red display at the center of the instruments.

 See the vehicle and RNS-E owner's manuals for information on using the DIS once this installation is complete.

Select "17-Instruments" on the Control Module Screen.



To change the adaptation values, press "Adaptation-10"

 **Do not Recode the Instruments It could cause a malfunction.**



Enter number 62 in the Channel Number box and press "Read". Enter a value of 5 and press "Save". This value is valid to enable the display of Radio and Navigation info.

See Section 4.3 for installations that include a telephone module.

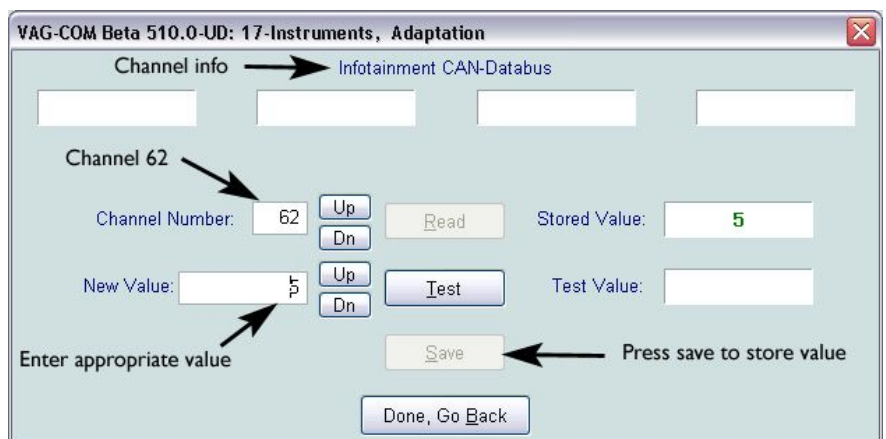

Exit back out of VAG-COM completely and disconnect the cable from the diagnostics port.

This completes the installation of the RNS-E navigation headunit.

Section 2 Satellite Radio Module

This section will describe how to install an OEM Audi satellite radio module in a vehicle that is not pre-wired for it from the factory. These instructions are specific to Audi vehicles with the CD Changer connection plug in the trunk. First, a note about this installation method. The SAT radio tuner uses the same wires to send audio signals to the headunit that the external CD changer (CDC) cable uses. If a phatbox or ipod adapter is plugged into the CDC port, the installation of the SAT module will require more work than is described here. There is a document on my website www.nsxjr.com that details how to install sat radio with a CDC or other device that uses the CDC port. The audio wires are the only potential conflict between the SAT module and the CDC port since they use separate connections for power and data.

i To resolve the audio wire conflict, the SAT radio has a built-in audio pass through for other devices. Three wires called CD-In Left, CD-In Right, and CD-In GND. These work such that when the SAT module is on, it sends its audio to the headunit and blocks out anything else. When it is turned off (i.e., switch to another source on the headunit), the SAT radio allows the signals from the audio inputs to pass through to the headunit. The Audio-IN pinouts can be seen on the SAT radio wiring diagram below. These audio inputs are where to connect the three audio wires (L, R, GND) from a Phatbox or iPod adapter. There's a schematic of the SAT and CDC connections together in **Appendix E**.

2.1 The Basics: SAT Radio Tuner Wiring Info

There are four categories of wires the SAT tuner requires:

- Power: Two wires in their own connector. Main source of power used to operate.
- Audio: Three wires: Left, Right, and Audio Ground. These send the audio to the headunit.
- Data: Two wires: CAN H and CAN L. For communication with the headunit of all other data.
- Antenna: Two wires: brown and green FAKRA terminals that the antenna connects to.

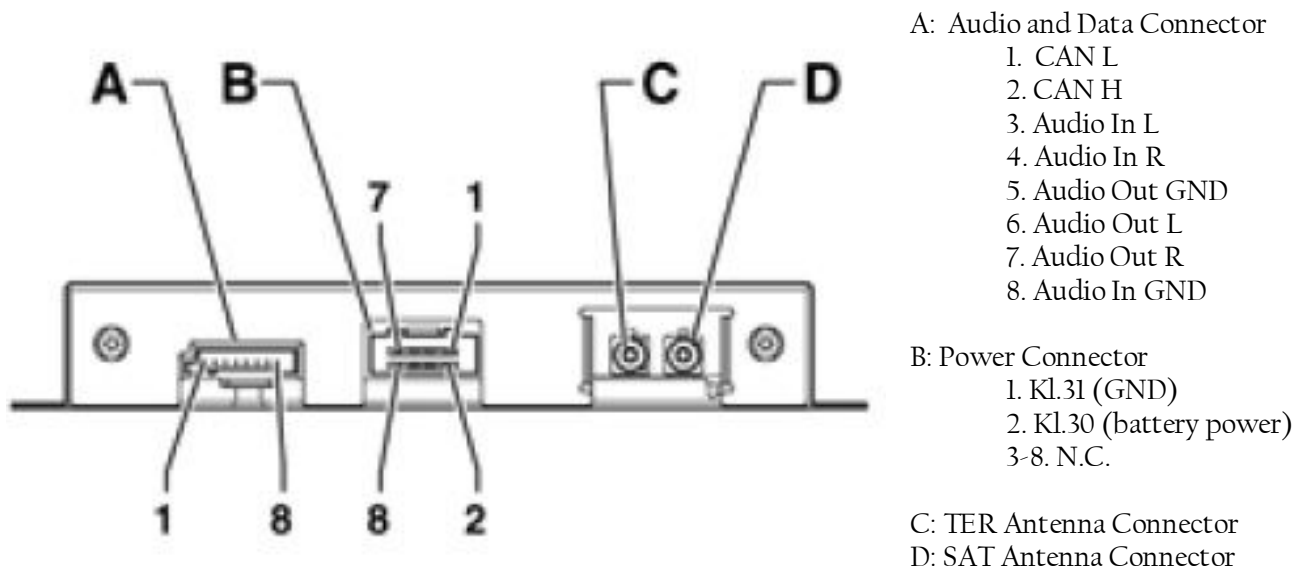

2.2 Power Wires

The SAT radio tuner will be located in the trunk and needs a power supply there. Luckily there is a good source of power from the correct fuse (#37) already in the trunk: a 2.5mm wire that carries the power from fuse #37 to the amp on the right side of the trunk.

Remove the trunk floor carpet and rear cross panel trim at the lip of the trunk. Remove the right side trunk trim, at least far enough to allow room to work with wiring at the amplifier. (See **Appendix F**)



The power wire to be tapped is HOT at all times. Disconnect the battery.



Do not use the power supply wires within the CDC harness for the SAT tuner module.

➔ Remove the wiring harness from the amplifier and splice into the +12V power wire. It is the large Red/Blue wire at Pin 13 of the Bose Amp connector. *For non-Bose amps, the wire is located in Pin 1.*

Reconnect the wiring harness to the amp and run a new wire, at least 18AWG in size, from the splice just made, across the rear of the trunk (under the cross panel trim), behind the left side trunk trim, into the hole where the SAT module will be installed. Reinstall all the trunk trim.



Alternative: connect a new power wire to the “30” connection on the power bank behind the fuse box and run to the trunk. An inline fuse between the SAT module and the power connection is required if this method is used.



➔ Install a new wire terminal onto the end of the power wire and install into Pin 2 of T8r. T8r is a new wire terminal housing in the picture above. It is a small connector with wires arranged in two rows of four wires each. Install another new wire terminal into Pin 1 of T8r and connect to ground in a convenient location. Check for good ground by using a multimeter to check voltage using the new power wire in Pin 2 for positive voltage. The power on this wire is hot at all times if the battery is connected. Close the wing sides into the T8r connector, it is complete.

2.3 Audio Wires

The existing CD changer harness already contains three wires that take audio signals from the trunk to the headunit. This installation will take advantage of them. The CDC plug is in the left side trunk panel kind of tucked up behind the tool kit. It is a large plug wrapped in grey foam. Pull it out and remove the foam cover. The custom wiring harness created in this step will have a female 13-pin DIN plug that mates to the CDC trunk plug. The other end of the custom harness will be the connector T8s. T8s is a small black 8-pin plug arranged in one row of 8 pins. This plug and new wire terminals can be purchased from Audi. Refer to the wiring diagrams for a visual description of the proper wiring pinouts described in this subsection. Prepare 3 lengths of wire with new wire terminals on one end only. Solder the loose ends of these 3 lengths to Pins 1,3,4 of the Female 13-pin plug. Slide the outside cover over the Female 13-pin plug. Connect the new wire terminal end of these 3 wires to the new wire housing T8s in this order:

- ➔ Female 13-pin DIN Pin 1 to Pin 7 of T8s (R CH sound)
- ➔ Female 13-pin DIN Pin 3 to Pin 6 of T8s (L CH sound)
- ➔ Female 13-pin DIN Pin 4 to Pin 5 of T8s (Spk GND)

Wrap the wires between the two ends of the harness with electrical tape. The custom wiring harness that plugs into the CDC plug is complete. Plug the round 13 pin connector end into the CDC plug in the trunk and wrap them with electrical tape to prevent them from separating. There are two more wires to connect to T8s in the next subsection.

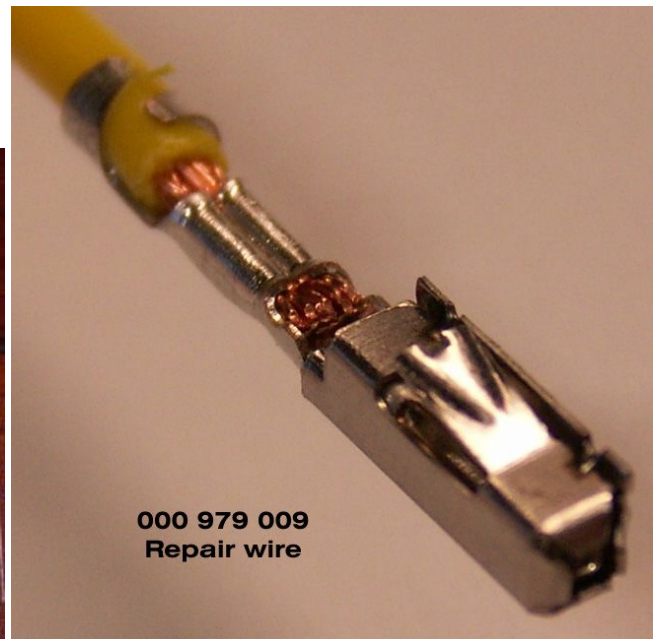
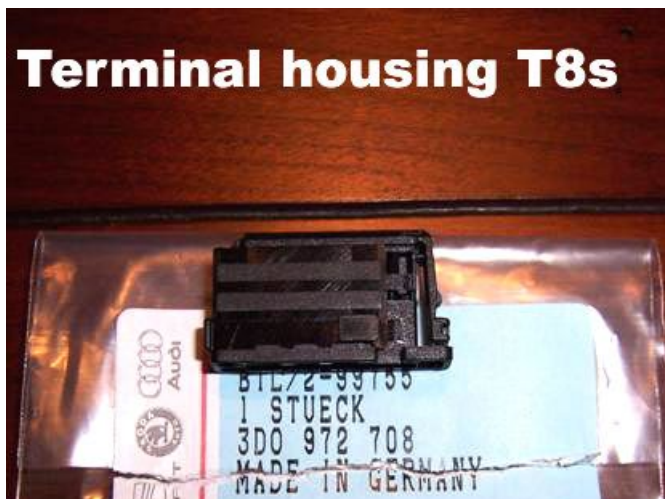

Custom wiring harness before taping

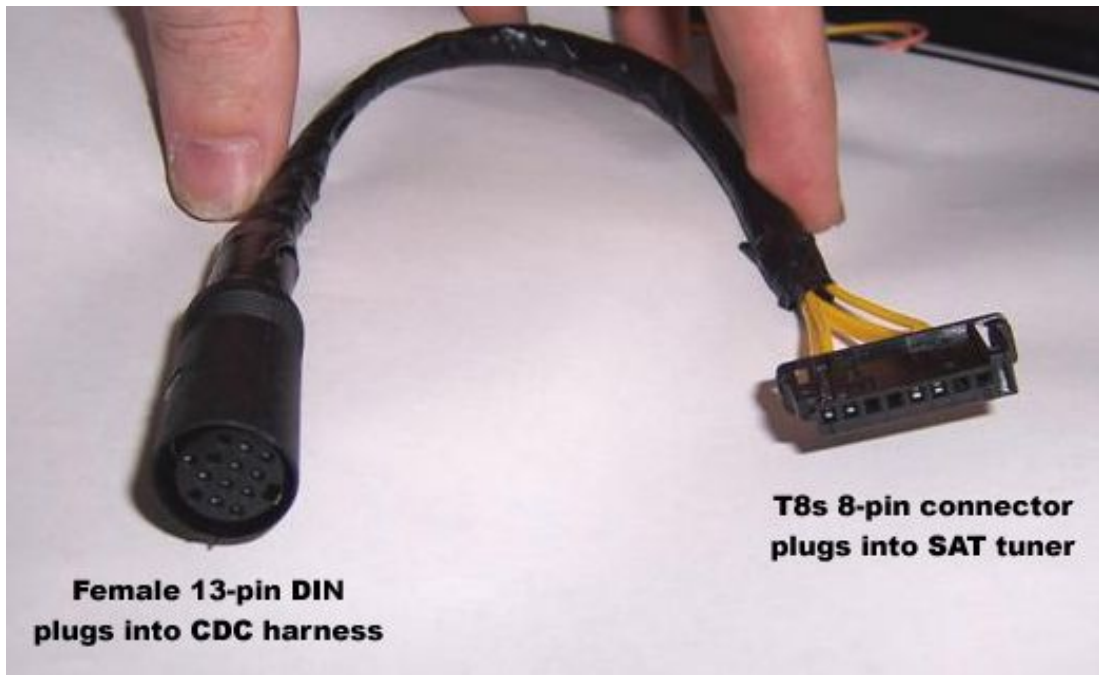
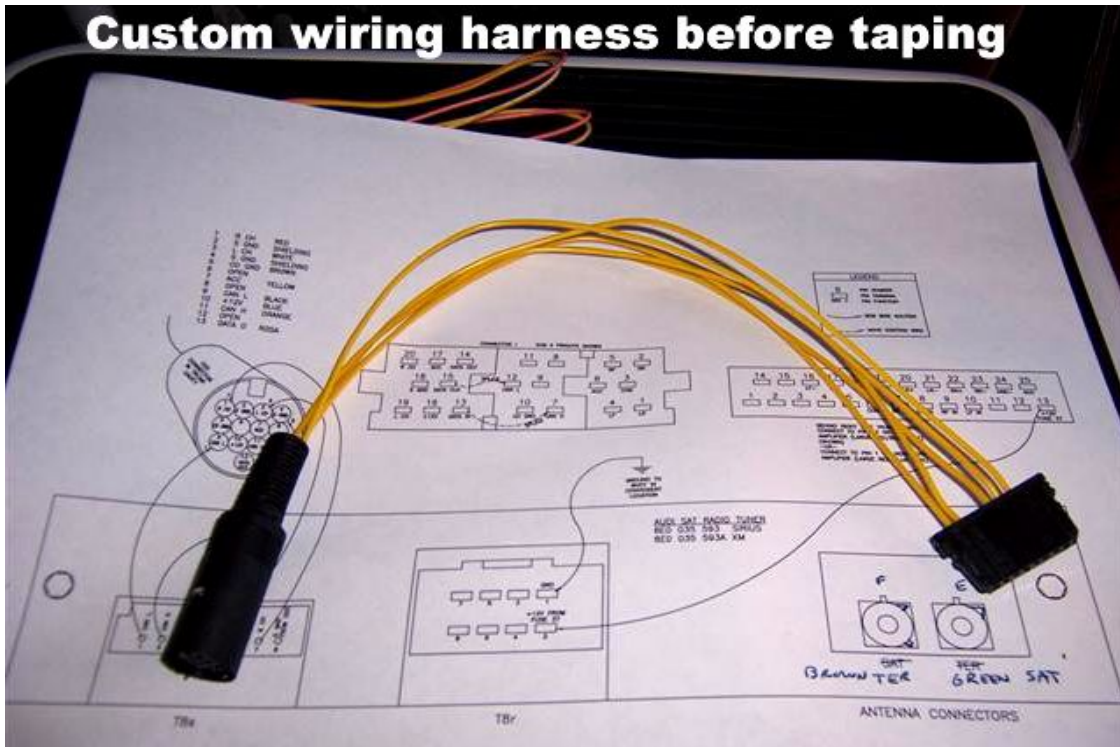

**Female 13-pin DIN
plugs into CDC harness**

**T8s 8-pin connector
plugs into SAT tuner**

2.5 Antenna Wires

With all the other wiring completed, the last step is the SAT antenna. The right antenna must be purchased for the SAT radio service planned for installation. The OEM Audi antenna will work for both SAT radio services, but requires a drilled hole in the roof to mount and the purchase of antenna cables and more connectors. This may be of interest to Avant owners that don't have the mounting location of the sedans. This did not interest me, so I bought an antenna and installed it below my rear parcel shelf, on top of the metal frame that supports it. I bought a slim Terk antenna XM3 and it slides



between the metal support and the top deck easily. As long as there is nothing metal between the antenna and the satellites it should work fine. A two lead antenna is required to plug into the SAT tuner. The newer antennas only have a single pink lead. This type of antenna must be installed with a splitter that will convert the single Pink lead to a dual green and brown lead. Once the antenna is installed, run the wires to the left side trunk panel where the SAT tuner module will be installed.

IMPORTANT NOTE ABOUT ANTENNAS

Audi is unique with the colors of their antenna leads. Most aftermarket antennas will have green (XM, white for Sirius) and “curry yellow” leads. The green (or white) is for terrestrial signals, the curry is for satellite signals. The connectors on the Audi OEM tuner are green and brown. For Audi, the green is for satellite signals, the brown is for terrestrial. These are FAKRA SMB type connectors and the colors correspond to the “key code” of the connector. The “key code” is just some tabs that keep some connectors from plugging into the wrong slot. Green is key code ‘E’, Curry is key code ‘K’, Brown is key code ‘F’, and White is a universal connector that will plug into any color socket.

➡ Terrestrial :	Audi Brown	XM Green	Sirius White
➡ Satellite:	Audi Green	XM Curry	Sirius Curry

On the antenna leads, swap the green connector to where the curry connector was. Buy a new brown FAKRA connector and connect to the lead that was previously green. Now the antenna can be plugged into the SAT tuner. (The same can be done for Sirius, but the white connector will plug into the green Audi socket.) The good thing about Terk brand antennas is that they use Amphenol brand connectors, so the new brown connector purchased from www.digikey.com will fit perfectly.

2.6 Completion

In the 2001 Audi there is not a “factory” place to install the SAT tuner. A good location is the slot where the CDC goes, attached with a hefty dose of Velcro. A SAT radio mount kit is available, but it only consists of 4 screws and 4 plastic nuts that have no purpose if the vehicle doesn’t have the “factory” mounting position. Mount the tuner and plug in the antenna connectors, power connector T8r, and audio connector T8s. All of these only plug in one way to prevent them from being incorrectly installed. With all the wires connected, ensure the SAT tuner module is well mounted and replace the trunk the access panel. The tuner should now show up in the radio “BAND” list if the RNS-E is coded to enable satellite radio (see section 1.4). The specific tuner type will appear in the list; in lieu of the term “Satellite Radio” it will list “XM Radio” or “Sirius Radio”. For activation, press the Setup button while in SAT radio mode and select the menu item to display the radio serial number.

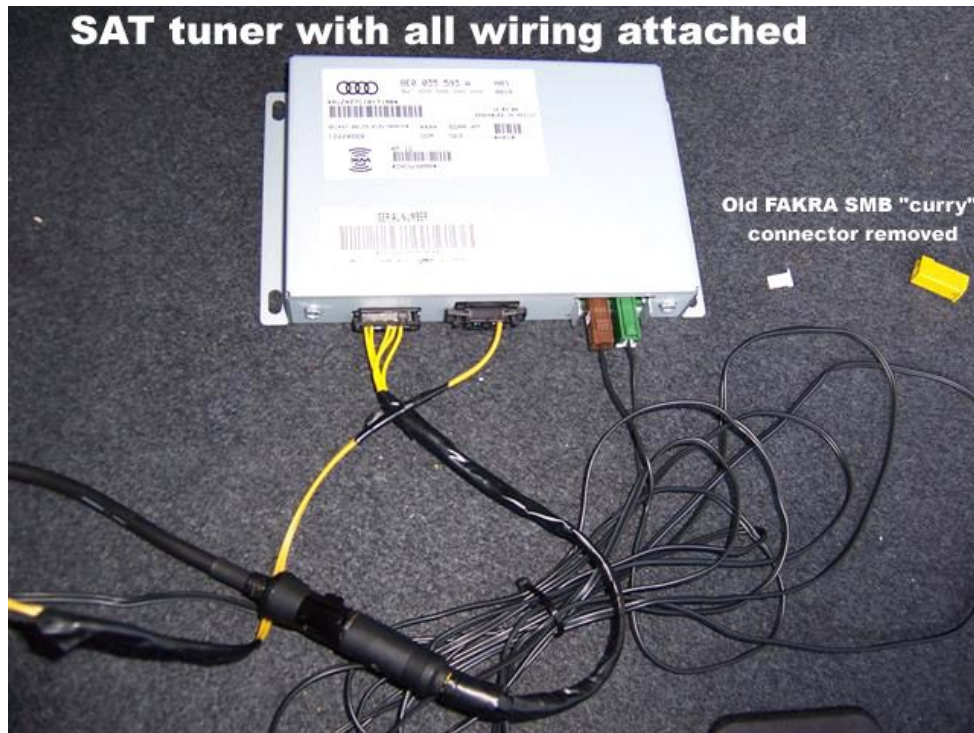

Section 3 Multifunction Steering Wheel

This section will describe how to change the multifunction steering wheel (MFSW) control unit to regain the use of the steering wheel controls with the RNS-E. These instructions are specific to vehicles with existing multifunction (audio/telephone) buttons on the steering wheel. The new installation of a MFSW into a vehicle with a regular steering wheel is far more complicated than the instructions given in this document.

The existing MFSW in the vehicle will work with the RNS-E, but the control unit must be changed. The MFSW uses an internal and external control unit. The internal unit (inside the steering wheel) reads in the actual button presses. It communicates the button data over a single data wire to the external control unit. The external module receives the data and relays it to the CANbus network. It also gathers data about interior illumination (for button lights), and ignition status (off or on) and relays that data over the same single data wire back to the internal control module for its use.

The external control unit is the one that must be replaced. This is because the existing control unit that operates with the Symphony I radio does not communicate via the CANbus language.



Section 1 must be completed for this installation to operate properly.



Look for a separate document to be available in the future on www.nsxjr.com covering the topic of retrofitting MFSW into vehicles originally equipped regular steering wheels.

3.1 MFSW Control Unit Installation

Remove the driver's side knee panel as discussed in Section 1.1. Look up into the foot well behind the fuse box and find the control unit, probably with the number 608 on the top. It will be on the middle row, far left side. Pull the 608 unit out and install the new 616 unit in its place. There is no rewiring to be done because the correct pins in the relay socket have been properly reassigned to the CANbus network based on the wiring already performed in Section 1. Reinstall the knee panel.

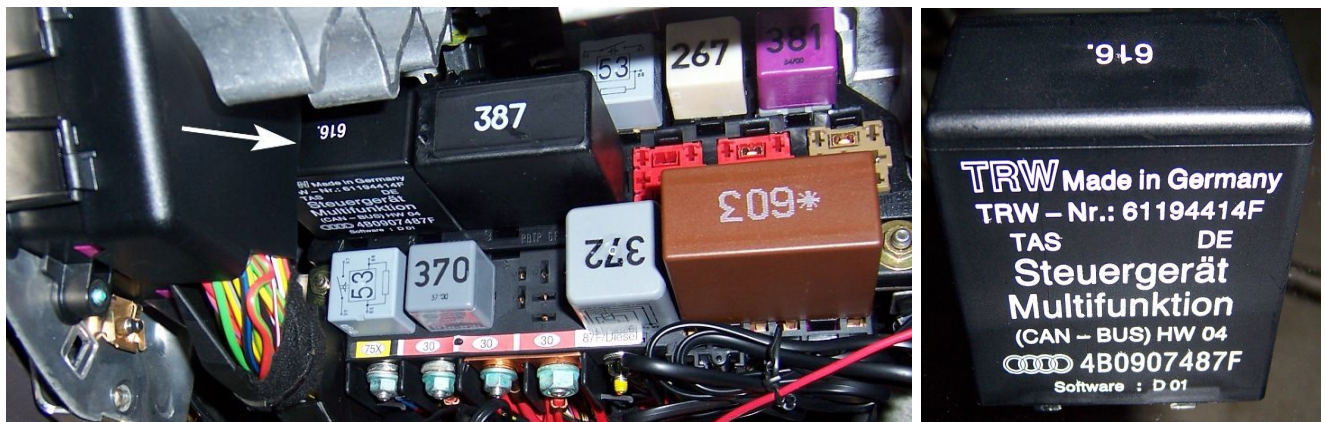

Special thanks to Eric C. of Boston for donating his 616 control unit for my installation.

3.2 Control Module Coding (VAG-COM)

The new MFSW control unit must be coded with VAG-COM to ensure proper operation.

From the Main VAG-COM screen, press “Select” under the Select Control Module area.



Select “16-Steering Wheel” on the Control Module Screen



The software is now connected to the new MFSW control unit in the “Open Controller” window. Note the Software Coding located just below the part number display. Check the chart on the next page to see what the coding means. If the coding is satisfactory, exit out of the VAG-COM software and skip the remainder of this section. If the control module needs to be recoded, continue with the steps below.



To change the coding, press “Recode-07”



Enter the new coding desired in the “Software Coding” box.

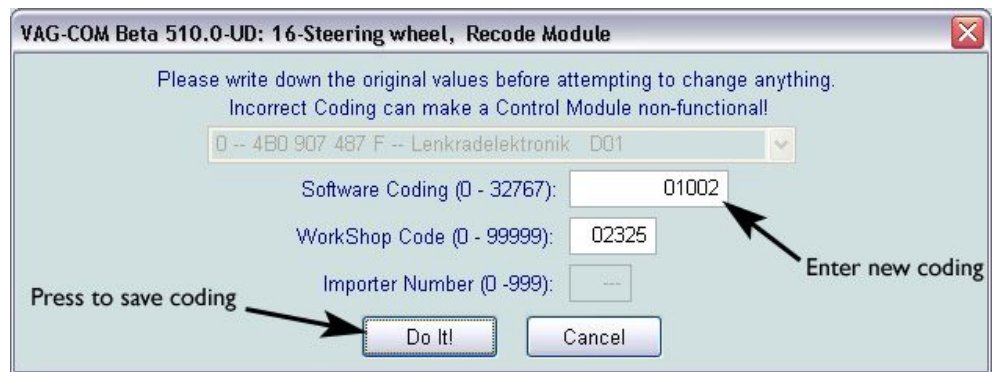

Verify that the new coding was accepted in the “Open Controller” window.

Exit VAG-COM.



Control module suffix "F" & "H"

X	X	X	X	X	Coding
X					Standard
0					always 0
	X				Radio on CAN-Bus
	1				always 1 (Radio on CAN)
		X	X		Tiptronic
		0	0		without Tiptronic "F"
		0	1		with Tiptronic "H"
				X	Steering wheel functions
				1	Radio & telephone operation
				2	Radio operation
				5	Radio, telephone & voice recognition/operation operation

Section 4 Bluetooth Telephone Module

This section will describe how to install an OEM Audi Bluetooth telephone module in vehicles that are equipped with analog telephone preparation wiring. This analog telephone preparation consists of the handsfree microphone near the sunroof dial, and the wiring harness that ends in the trunk with a DB25 female connector. If the vehicle is equipped with the BOSE audio system, there will also be a small telephone audio speaker in the middle portion of the B-pillar trim. This small speaker will not be used with the RNS-E audio system. If the vehicle is actually equipped with the full analog telephone kit, there will also be a handset in the armrest and a telephone transceiver in the trunk. These two items can be removed from the vehicle if present.



This installation requires the presence of the telephone connections within the RNS-E PNP Harness (TEL Mute, TEL NF IN+, TEL NF IN-). See Section 1.3.2 for detail.



Reminder: this document is specific to vehicles originally equipped with Symphony I radios. Vehicles with Symphony II radios were equipped with newer telephone transceiver modules located under the passenger's seat instead of in the trunk. This type of module uses a 42-pin connector instead of a DB25 connector. The wiring in this section does not apply to vehicles equipped with the newer telephone transceiver modules.

4.1 Custom Wiring Harness

Almost every connection required of the new BT telephone module is already present in the female DB25 connector in the trunk. In this subsection, a custom wiring harness will be made to allow the new BT module to plug into this connector.

The DB25 connector is tucked up behind the toolkit on the left side of the trunk, similar to the location of the CD changer plug. If the analog transceiver box was installed in the vehicle, the DB25 connector will be liberated once the existing transceiver is removed. There will also be an antenna connection bundled with this connector. This antenna will not be used in this installation.

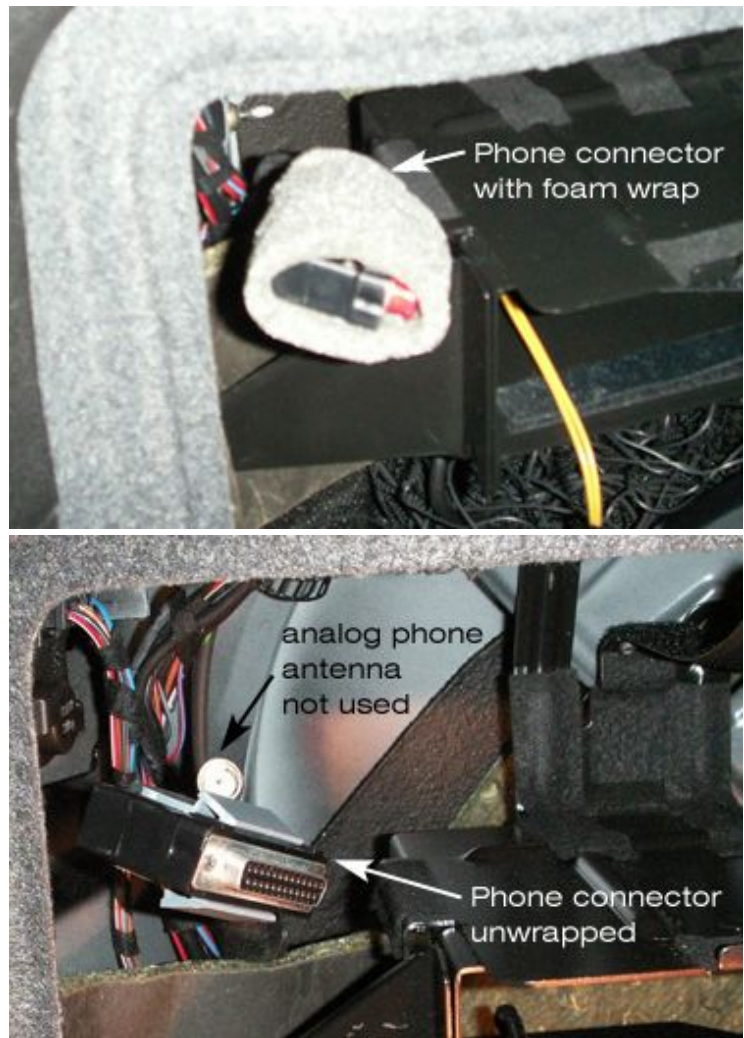
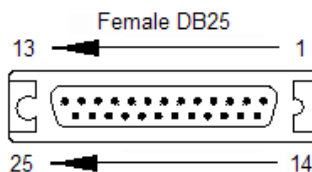

Next, construct the custom wiring harness using the wiring connections shown in the chart below. The wire gauges are listed for information only. This is to prove that the wires supplied in the 25-pin telephone harness are of sufficient size when compared to the required size listed for the BT module. The parts required to make this cable are the 54-pin plug, 5 repair wires, and a DB25 (D-sub) male terminal with hood. These parts are shown in the surrounding pictures.

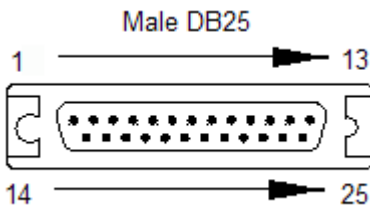

Custom Harness wiring chart for DB25 Analog Phone to 54-pin Bluetooth Phone

BT Tel module (54-pin)			Connection	Existing TEL connector (DB25)		
notes	gauge	pin		pin	gauge	notes
Power +12V	0.5	1	KL.30	4	0.5	
Ground	0.5	2	KL.31	3	1.0	
Tel audio out to HU	0.5	8	NF OUT+	19	0.5	
Tel audio out to HU	0.5	9	NF OUT-	25	0.5	
Microphone input	0.35	11	MIC IN+	15	0.35	
Microphone input	0.35	12	MIC IN-	14	0.35	
Diagnostics	0.35	15	K-line	12	0.35	See Section 4.2
Tel Mute trigger to HU	0.5	16	Mute	10	0.5	
infotainment bus	0.35	17	CAN H	N.C.		CAT5 wire to CANbus
infotainment bus	0.35	18	CAN L	N.C.		CAT5 wire to CANbus

To make the harness, snip each repair wire in half. The pin terminal end will be inserted into the 54-pin connector. The bare end can then be stripped of insulation and crimped into the small pins supplied with the male DB25 connector. These small pins may simply be snapped into the correct openings (based on the wiring chart) in the male DB25 connector. Once all the connections are made, the 54-pin connector can be assembled by sliding the blue inner portion into the black outer shell. The DB25 connector may also be assembled by attaching the connector hood to protect the wire-to-pin connections. The final product is shown in the picture below. Also notice below that the CANbus wires do not connect to the DB25 connector. As described in Section 2 of this document, there are CANbus wire pairs already available in the trunk if the satellite radio tuner was installed. CANbus is not available within the DB25 telephone connector already installed. For this installation, a spare CANbus pair was used from the CAT5 cable that is connected to the CANbus distribution panel (see separate install guide on www.nsxjr.com) in the vehicle. Another option is to splice into the CAN H and CAN L wires that supply that satellite radio tuner if installed. If neither of these options are available, please follow the instructions in section 2.4 of this document to install a new CANbus wire pair into the trunk.

The picture below shows a two pin white Molex disconnect plug installed onto the CANbus wire pair. This step is not required, but does facilitate quick connection and disconnection of the entire custom wiring harness. To install without this plug, simply connect the CANbus wires from the vehicle to the correct pins on the 54-pin connector.

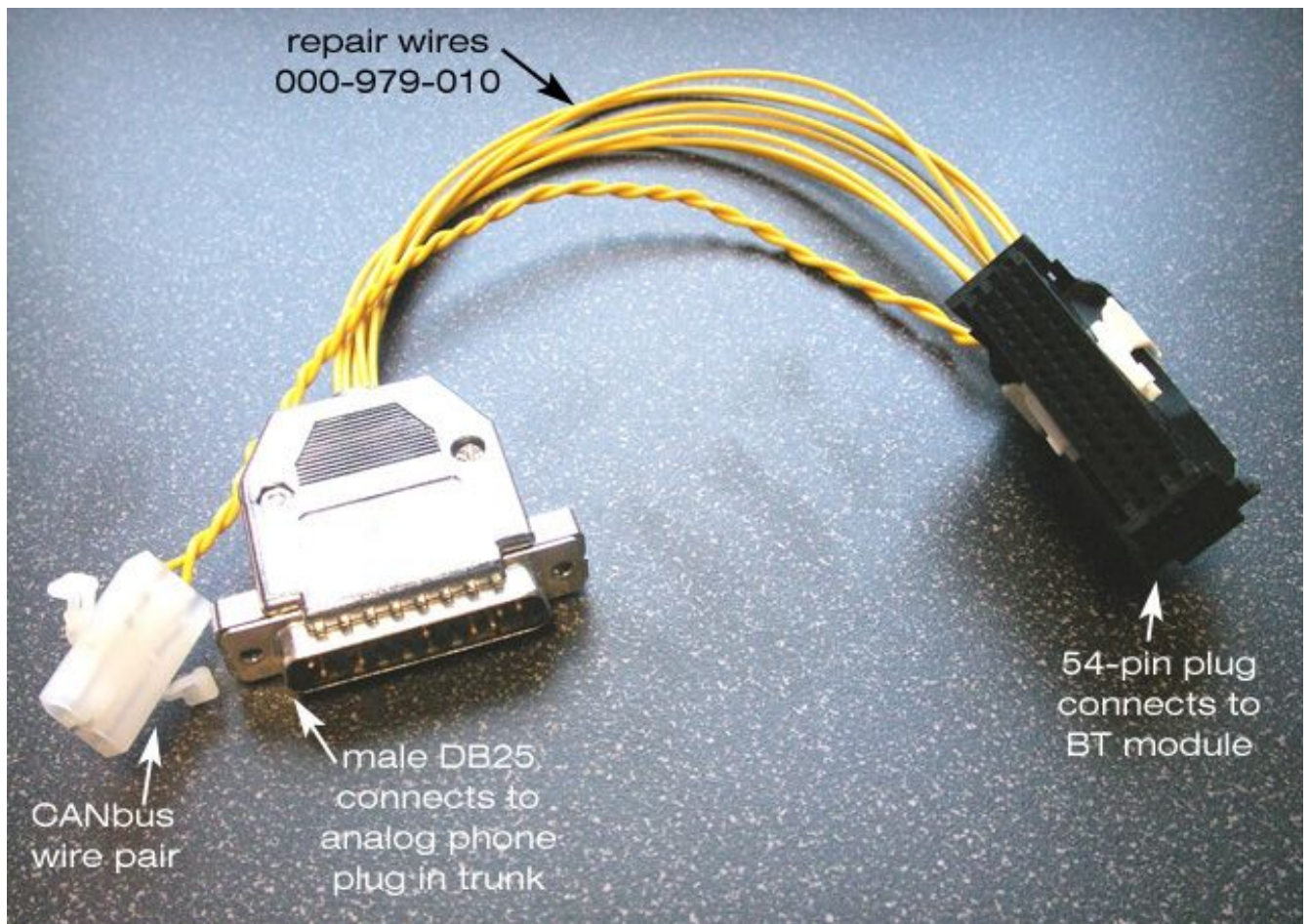

The Bluetooth module is shown below fully connected to the vehicle. The final mounting location is not shown, but a convenient location is on top of the satellite radio tuner, attached with Velcro.



When mounting the BT module, ensure that the location is secure and that the antenna will not be susceptible to movement or actions that may cause damage.

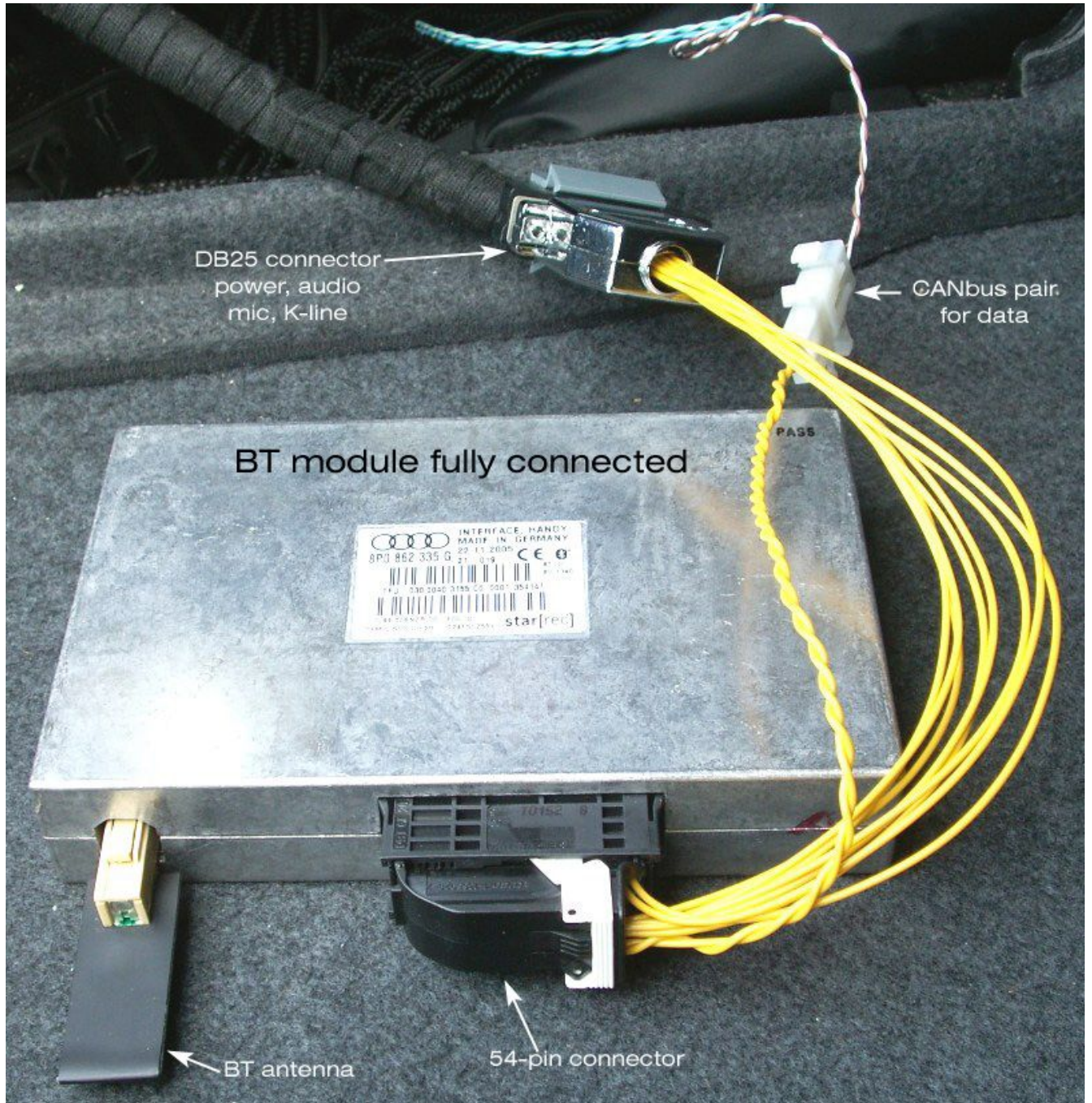

4.2 Connecting the K-line

The K-line is an important connection for the BT telephone module because this is how it communicates with VAG-COM or other diagnostic software. Without this, the BT module will not be able to be coded to ensure proper operation in the next section. There is no K-line connection in the original DB25 phone connector in the trunk. However, there is a simple way to connect this without having to run new wires into the trunk.

The DB25 phone connector harness includes other wires not listed in the chart in the previous section. In particular, there are three wires that connected the trunk to the multifunction steering wheel control unit. These are data wires that the old analog phone system used for communication. These wires are not needed for the new Bluetooth phone module because it uses CANbus for communication. This section will describe how to “hijack” one of these dormant data lines to take the K-line connection into the trunk.

The DB25 phone connector is connected to the front of the car by passing through the left side A-pillar station. This is the same connector station as shown in section 1.2 to tap into the Reverse Wire signal for the RNS-E. This location is also conveniently close to the VAG diagnostic connector under the dash. By making one simple connection, the K-line can be connected to the proper pin at this station.

Remove the driver’s side knee panel (see section 1.1) and left side lower A-pillar trim.

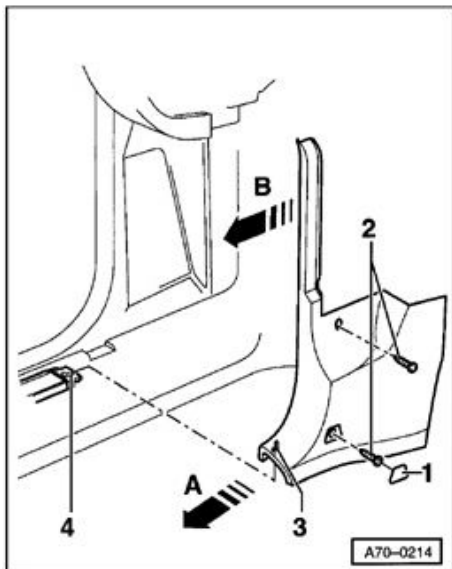

Lower A-pillar trim, removing and installing

- Pry out cover - **1** - .
- Remove screws - **2** - (2x). Tightening torque: 2.5 Nm (22 in lb)
- Pull lower A-pillar trim in direction of arrow - **A** - until pin - **3** - can be detached from groove - **4** - .
- Pull extension of lower A-pillar trim in direction of arrow - **B** - out of retainers (2x).

Locate Connector T15s, the blue 15-pin connector near the top in this connection station. Pull this connector out to give enough room to disassemble the housing and change the wiring inside.



Once unplugged, the top portion can be removed by sliding off as shown.

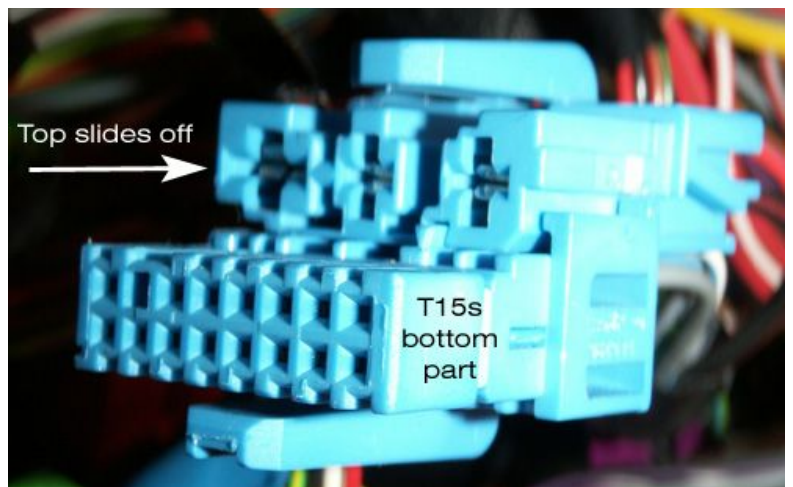

Now the cover can be removed from the bottom section to reveal and unlock the wiring pins inside.

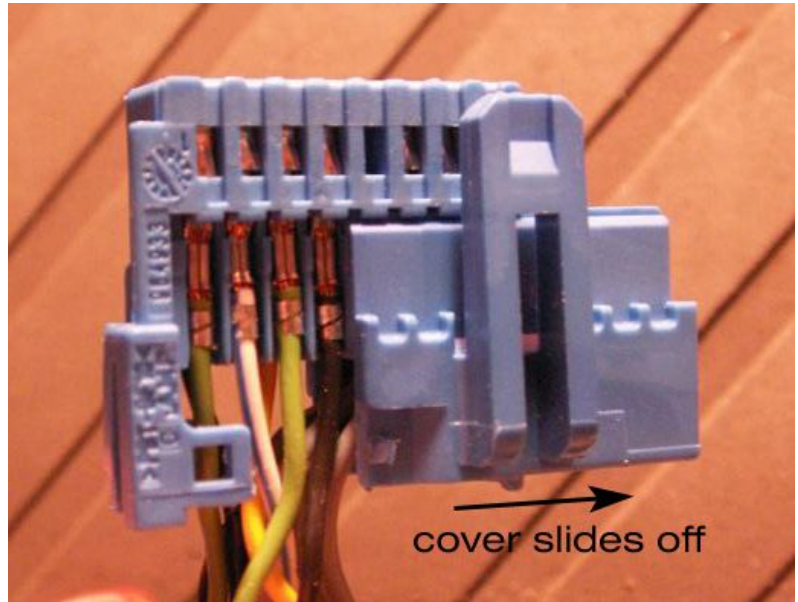

Pin 13 in this connector is a small grey wire to be replaced. Simply use a small screwdriver or knife blade to disengage the locking tab on the grey wire and gently pull out from the rear. This will be very similar to the wiring in section 1.1.1 of this document to remove the pins from the 32-pin instrument cluster plug. Once the grey wire is removed from pin 13, tape the contact end off and tuck away into the wiring harness. This pin will not be used and is not connected to anything, but there's no reason to cut it off completely.

➡ Insert a new repair wire (000-979-009) into pin 13 of the connector T15s.

Re-assemble the blue wire housing plug by sliding the cover back on then sliding the top portion back on with the three larger wire pins. Plug the connector back into its position in the connector station. This wire is now connected to pin 12 in the DB25 connector in the trunk which connects to pin 15 at the Bluetooth module through the custom harness assembled in the previous subsection.

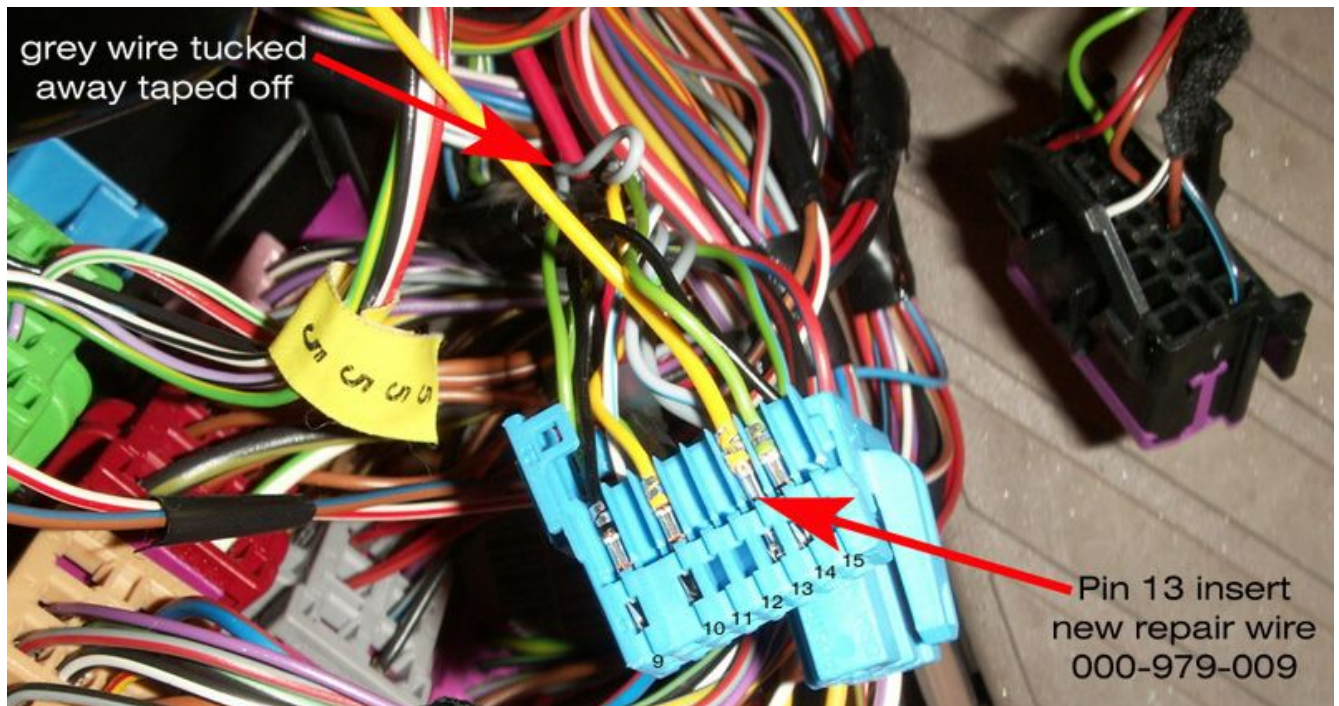

The final step of this section is to splice the other end of the repair wire into the K-line. The K-line is the small green wire that connects to pin 7 in the VAG diagnostic connector. In the picture below, a small section of the wire tape was removed a few inches back from the connector end. The small green wire was spliced using a red (18-22AWG) wire splice tap. Secure the repair wire by taping off to other wiring harnesses or by using cable ties. Using fabric tape, wrap the section of the VAG connector wiring harness that was just spliced to hide the work and protect the connection.

Reinstall the left side lower A-pillar trim and driver's side knee panel.

The physical installation of the Bluetooth telephone module is complete.



4.3 Control Module Coding (VAG-COM)

The BT module, RNS-E, instrument cluster, and MFSW must be coded to ensure proper operation. Connect a diagnostic cable to the vehicle and start the VAG-COM software on the computer.

i In lieu of using VAG-COM software, the vehicle can be coded at any Audi dealership. Expect to pay for this service.

i VAG-COM Release 512 is recommended.

From the Main VAG-COM screen, press “Select” under the Select Control Module area.



Select the “Electronics I” tab at the top of the list, then select “77-Telephone” on the Control Module Screen.



The software is now connected to the TEL module in the “Open Controller” window. Note the Software Coding located just below the part number display. Check the chart on the next page to see what the coding means. If the coding is satisfactory, exit out of the VAG-COM software and skip the recoding instructions directly to the adaptation settings. If the control module needs to be recoded, continue with the steps below.

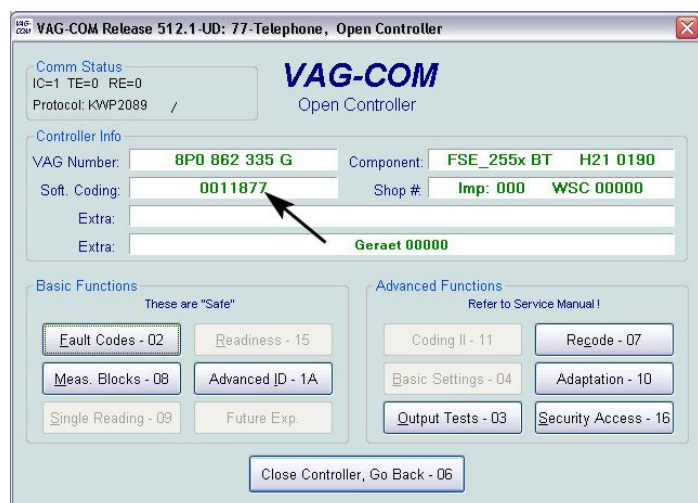

Control Module Coding Chart for Bluetooth Telephone Module

00?xxxx: *type (car)*

- 0 - with CAN-bus (A2, A3, TT)
- 1 - D3/C6 High-System
- 2 - C6 Standard-System Not used with US-Spec Bluetooth Module

00x?xxx: *type (Steering wheel)*

- 0 - non multifunction steering wheel
- 1 - standard steering wheel
- 2 - modular steering wheel Not used with US-Spec Bluetooth Module

00xx?xx: *installed components*

- 1 - none * WARNING: Do Not Use, this will immediately disconnect your K-line *
- 2 - MFSW * WARNING: Do Not Use, this will immediately disconnect your K-line *
- 3 - Headunit * WARNING: Do Not Use, this will immediately disconnect your K-line *
- 4 - MFSW and Headunit * WARNING: Do Not Use, this will immediately disconnect your K-line *
- 5 - K-line
- 6 - MFSW and K-line
- 7 - Headunit and K-line
- 8 - MFSW, Headunit and K-line

00xxx?x: *language for voice control*

- 0 - voice control off
- 1 - German Not used with US-Spec Bluetooth Module
- 2 - English (UK) Not used with US-Spec Bluetooth Module
- 3 - French Not used with US-Spec Bluetooth Module
- 4 - Italian Not used with US-Spec Bluetooth Module
- 5 - Spanish Not used with US-Spec Bluetooth Module
- 7 - English (US)
- 8 - Voice control from external device (i.e. RNS-E)

00xxxx?: *Language for DIS*

- 0 - no DIS display
- 1 - German Not used with US-Spec Bluetooth Module
- 2 - English (UK) Not used with US-Spec Bluetooth Module
- 3 - French Not used with US-Spec Bluetooth Module
- 4 - Italian Not used with US-Spec Bluetooth Module
- 5 - Spanish Not used with US-Spec Bluetooth Module
- 7 - English (US)

To change the coding, press “Recode-07”



Enter the new coding desired in the “Software Coding” box.

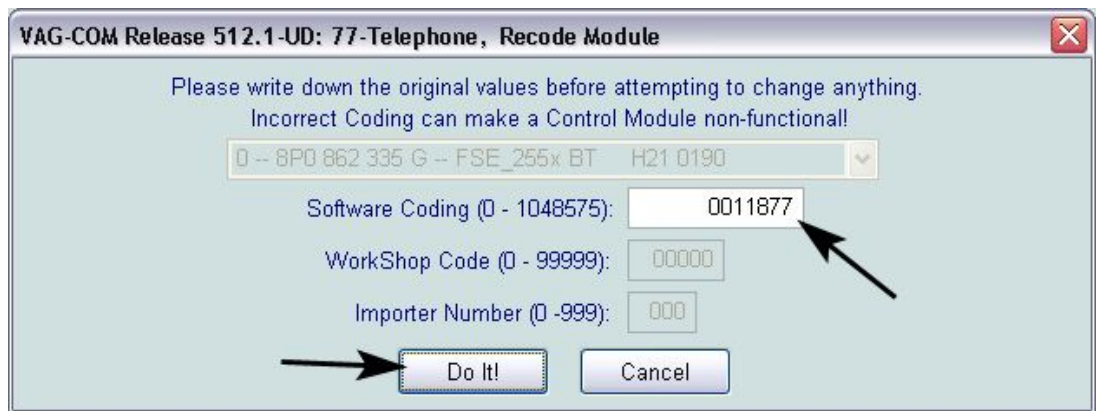

Verify that the new coding was accepted in the “Open Controller” window.



To change the adaptation values, press “Adaptation-10”



Scroll through each adaptation channel that is listed in the chart below. Enter the correct value based on the vehicle characteristics. When finished, press “Done, Go Back”.

Exit back to the main VAG-COM screen when finished.



 No adaptation values were altered for my installation. My speaker and microphone volumes require no correction.

Control Module Adaptation Chart for Bluetooth Telephone Module

-> **Channel 128** (Base Volume)
 000 - 0dB (no increase/decrease)
 001 - +1dB increase
 003 - +3dB increase
 006 - +6dB increase
 128 - -1dB decrease
 130 - -3dB decrease
 133 - -6dB decrease

-> **Channel 129** time after ignition off
 000 - 30 Seconds
 001 - 5 Minutes
 002 - 10 Minutes
 240 - 20 Hours

-> **Channel 133** (BT)
 BT activate/deactivate.

-> **Channel 134** (handsfree)
 0 - handsfree over BT
 1 - handsfree only with mobile in cradle

-> **Channel 131** (Microphone Sensitivity)
 000 - 0dB (no increase/decrease)
 001 - +1dB increase
 002 - +2dB increase
 003 - +3dB increase
 004 - +4dB increase
 005 - +5dB increase
 006 - +6dB increase
 128 - -1dB decrease
 129 - -2dB decrease
 130 - -3dB decrease
 131 - -4dB decrease
 132 - -5dB decrease
 133 - -6dB decrease

-> **Channel 135** (Bluetooth PIN)
 default: 1234

(The Bluetooth PIN can be set within the RNS-E menu system at any time.)

The next step is to code the RNS-E to recognize the Bluetooth Module data over CANbus.



The RNS-E unit must be running at least US firmware version 0110 for telephone functions to be activated. This firmware is on the North America Version 2A DVD.

Select “37-Navigation” or “56-Radio” on the Control Module Screen. Either option will access the RNS-E for coding.



The software is now connected to the RNS-E in the “Open Controller” window. Note the Software Coding located just below the part number display. Check the chart on the next page to see what the coding means. If the coding is satisfactory, exit out of the VAG-COM software and skip the recoding instructions. If the control module needs to be recoded, continue with the steps below.



Control Module Coding Chart for RNS-E Navigation Unit

Only the 5th digit needs to be changed and a value of “6” must be used.

0xxx?xx: Telephone / Telematics

- | | |
|--|--|
| 1 – No Telephone | |
| 2 – Telephone (Temic) | Not used with US-Spec Bluetooth Module |
| 3 – Telephone (Cullman) | Not used with US-Spec Bluetooth Module |
| 4 – Telephone (Nokia) | Not used with US-Spec Bluetooth Module |
| 5 – Telematic EU | Not used with US-Spec Bluetooth Module |
| 6 – Telematic US | |
| 7 – Mobile phone preparation self-diagnostic-able with comfort operation | |

To change the coding, press “Recode-07”



Enter the new coding desired in the “Software Coding” box.

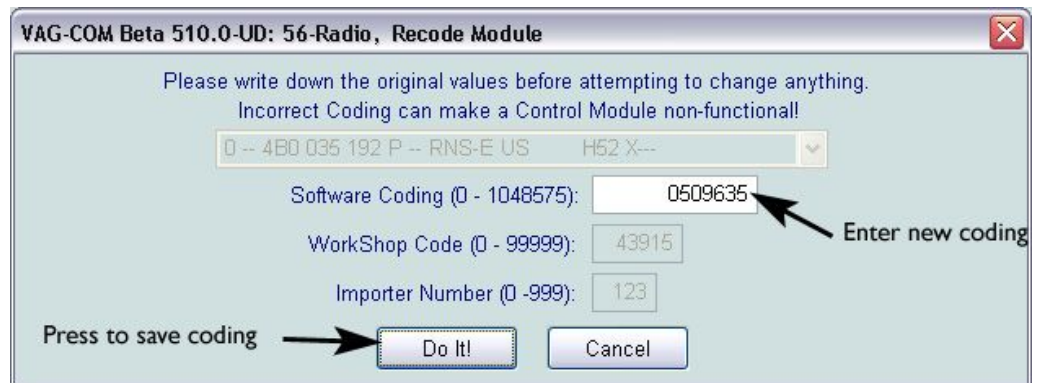

Verify that the new coding was accepted in the “Open Controller” window.

Exit back to the main VAG-COM screen when finished.



This step will adapt the instrument cluster to recognize the telephone data for use in the Driver's Information System (DIS). This is the small red display at the center of the instruments.

 See the vehicle and RNS-E owner's manuals for information on using the DIS once this installation is complete.

Select "17-Instruments" on the Control Module Screen.



To change the adaptation values, press "Adaptation-10"



**Do not Recode the Instruments
It could cause a malfunction.**



Enter number 62 in the Channel Number box and press "Read". Enter a value of 7 and press "Save". This value is valid to enable the display of Radio, Navigation, and Telephone info.

Exit back to the main VAG-COM screen when finished.

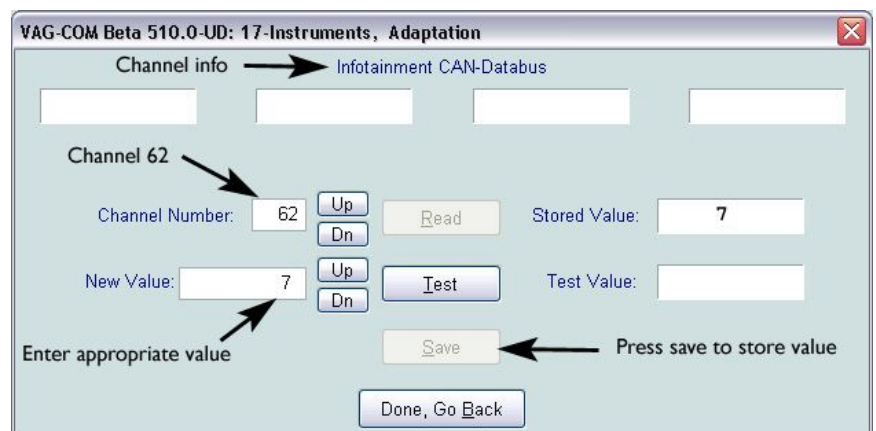

This last step will recode the MFSW control unit to enable telephone and voice activation operation.

Select "16-Steering Wheel" on the Control Module Screen



The software is now connected to the new MFSW control unit in the "Open Controller" window. Note the Software Coding located just below the part number display. Check the chart below to see what the coding means. If the coding is satisfactory, exit out of the VAG-COM software and skip the remainder of this section. If the control module needs to be recoded, continue with the steps below.



Control module suffix "F" & "H"

The last digit of the software coding is the only one to be changed in this step. To enable radio and telephone buttons only, a value of "1" should be used. To also enable voice recognition, a value of "5" should be used.



Voice recognition allows the driver to press the  button to activate the mode. The driver can then speak commands to redial, dial digits, or voice dial with saved voice tags. See **Appendix K** for more information.

X	X	X	X	X	Coding
X					Standard
0					always 0
	X				Radio on CAN-Bus
	1				always 1 (Radio on CAN)
		X	X		Tiptronic
		0	0		without Tiptronic "F"
		0	1		with Tiptronic "H"
				X	Steering wheel functions
				1	Radio & telephone operation
				2	Radio operation
				5	Radio, telephone & voice recognition/operation

To change the coding, press “Recode-07”



Enter the new coding desired in the “Software Coding” box.

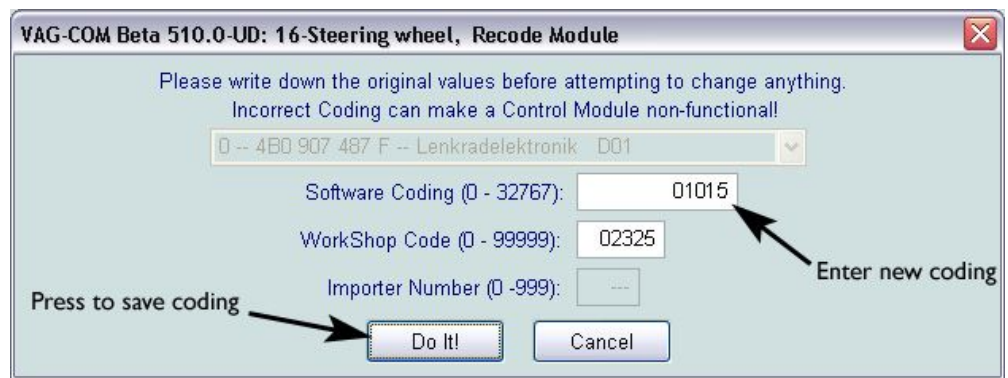

Verify that the new coding was accepted in the “Open Controller” window.



Exit back out of VAG-COM completely and disconnect the cable from the diagnostics port.

This completes the installation of the Bluetooth Telephone Module.

Appendix A

Parts List

Part Number	Description	Qty
	Section 1	
4B0 035 192P	RNS-E Navigation Unit	1
	Plug-and-play wiring harness	1
	GPS Antenna with FAKRA connector end	1
	Radio antenna adapter	1
	Radio removal tools	4
	Navigation DVD	1
	A few feet of 18 AWG wire, wire taps and connectors (for reverse wire)	

Section 2

8E0 035 593E	OEM XM Satellite Radio Tuner	1
XM3	Terk XM antenna	1
3D0 972 708	Wire terminal housing for SAT T8s	1
3B0 972 724	Wire terminal housing for SAT T8r	1
000 979 009	wire terminal for SAT T8s	3
000 979 131	wire terminal for SAT T8r	1
SD-130J	Female 13-pin DIN plug (mates to CDC harness) www.digikey.com	1
FAI-NFSJ-C01-0	FAKRA SMB connector, straight, "F"(SAT brown) www.digikey.com	1
	15' of CAT-5 cable	
	A few feet of 18 AWG wire, wire taps and connectors (for power wire)	

Section 3

4B0 907 487F	MFSW control unit CANbus – w/o tiptronic controls “616”	1
	-OR-	
4B0 907 487H	MFSW control unit CANbus – with tiptronic controls “618”	1

Section 4

8P0 862 335 G	OEM Bluetooth Tel Module	1
4E0 972 144	54-pin connector	1
000 979 010	Repair wire for 54-pin connector	5
000 979 009	Repair wire for T15s blue connector at A-pillar station, left	1
8P0 035 503E	OEM Bluetooth Antenna	1
	DB25 D-Sub male connector with crimp terminals and cover	1

Satellite Tuner Reference List

Part Number	Works with...	SAT provider
8E0 035 593	All Symphony & Concert units with SAT button, excl. vehicles w/TPMS	Sirius
8E0 035 593A	All Symphony & Concert units with SAT button, excl. vehicles w/TPMS	XM
8E0 035 593D	RNS-E, also all Symphony & Concert units with SAT button	Sirius
8E0 035 593E	RNS-E, also all Symphony & Concert units with SAT button	XM
4E0 035 593	C6 ('05+ A6) and D3 ('04+ A8) only (w/MOST audio network)	Sirius
4E0 035 593A	C6 ('05+ A6) and D3 ('04+ A8) only (w/MOST audio network)	XM

The middle portion of the SAT tuner part number may be “057” to indicate an “accessory” part instead of factory installed “035”.

The RNS-E unit has a built in diagnostics display called Engineering Mode. To enter this mode, follow these steps with the headunit on:

1. Press the “NAV” button and release.
2. Press the upper left soft key for over 5 seconds then release.
3. Press the upper right soft key until Engineering Mode appears then release.

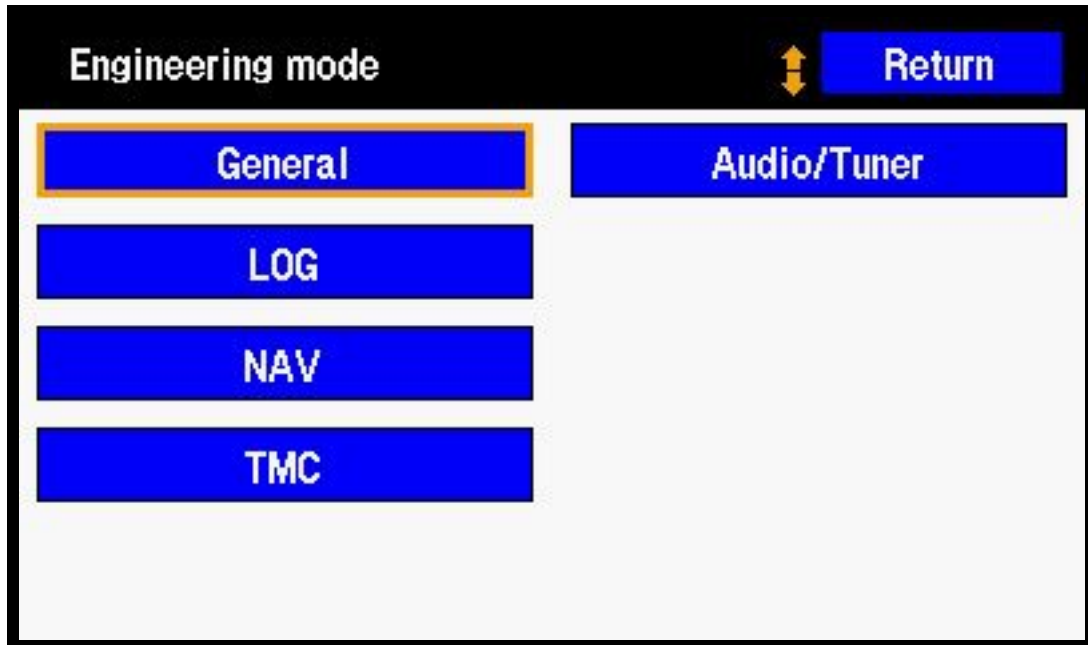

Enter Engineering Mode on the RNS-E (see Appendix B). Use the control knob to select the Audio/Tuner button and then select the SDARS testmenu. This screen is full of values that describe the operation of the SAT tuner. SAT1, SAT2, and TERR are the “addresses” of the signals it is receiving. SAT1BER, SAT2BER, and TERRBER are the Bit Error Rate of the signals it is receiving. This number is a HEX value that represents a percentage of bits that are received in error. Therefore, a “0000” means that it has zero percent error, or perfect signal. If it has a “270A” for any BER value (equals 99.99% error) that means it is not receiving any signal from that source. The SAT1 or SAT2 BER should be under 3% (012C) and the TERRBER should be under 6% (0258) to ensure a good listening experience. On the RNS these four digit hex values are listed out of order. For an actual value of “1234”, the digits are listed in the order “3412”. By this logic, the display of “0A27” translates to “270A” which means “no signal” as described earlier. To exit engineering mode press the return button a few times until the unit is back to the regular navigation screen.

 This information is for XM and I can neither confirm nor deny its existence or relevance to Sirius.

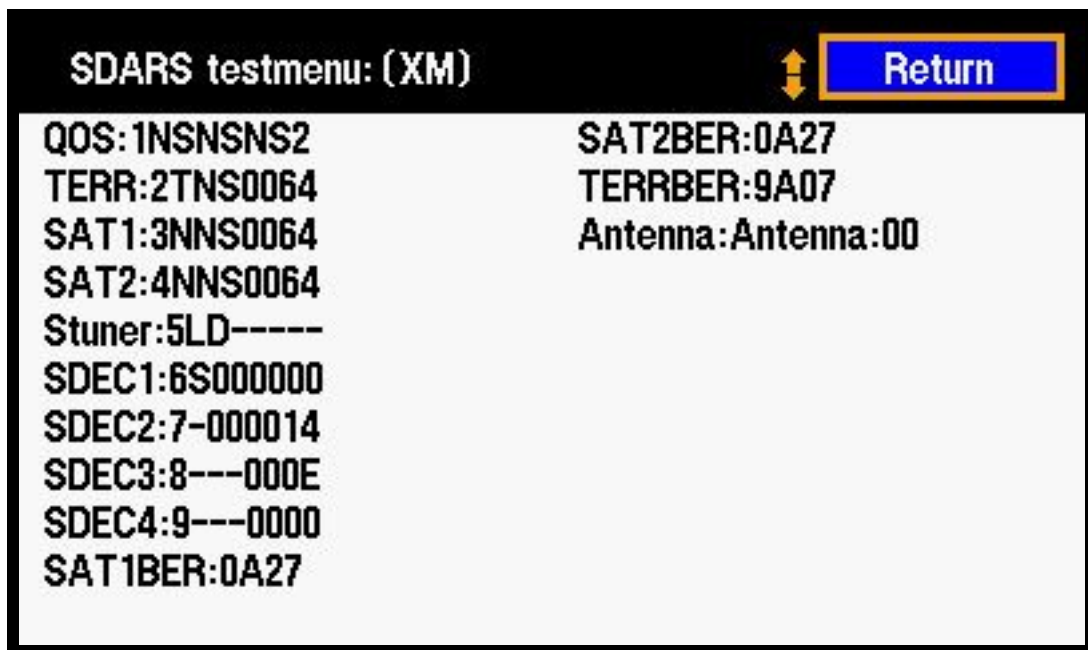
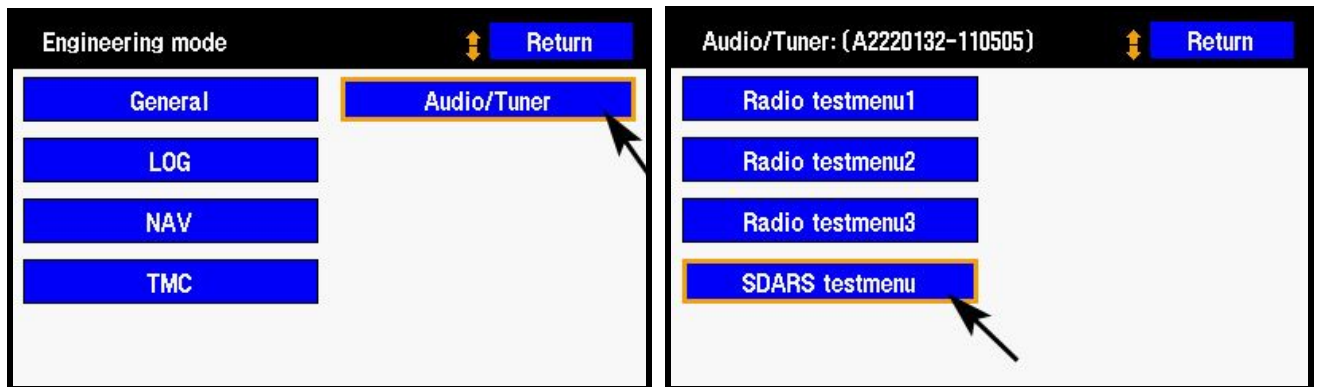

Appendix D Symphony I to RNS-E Wiring Diagram

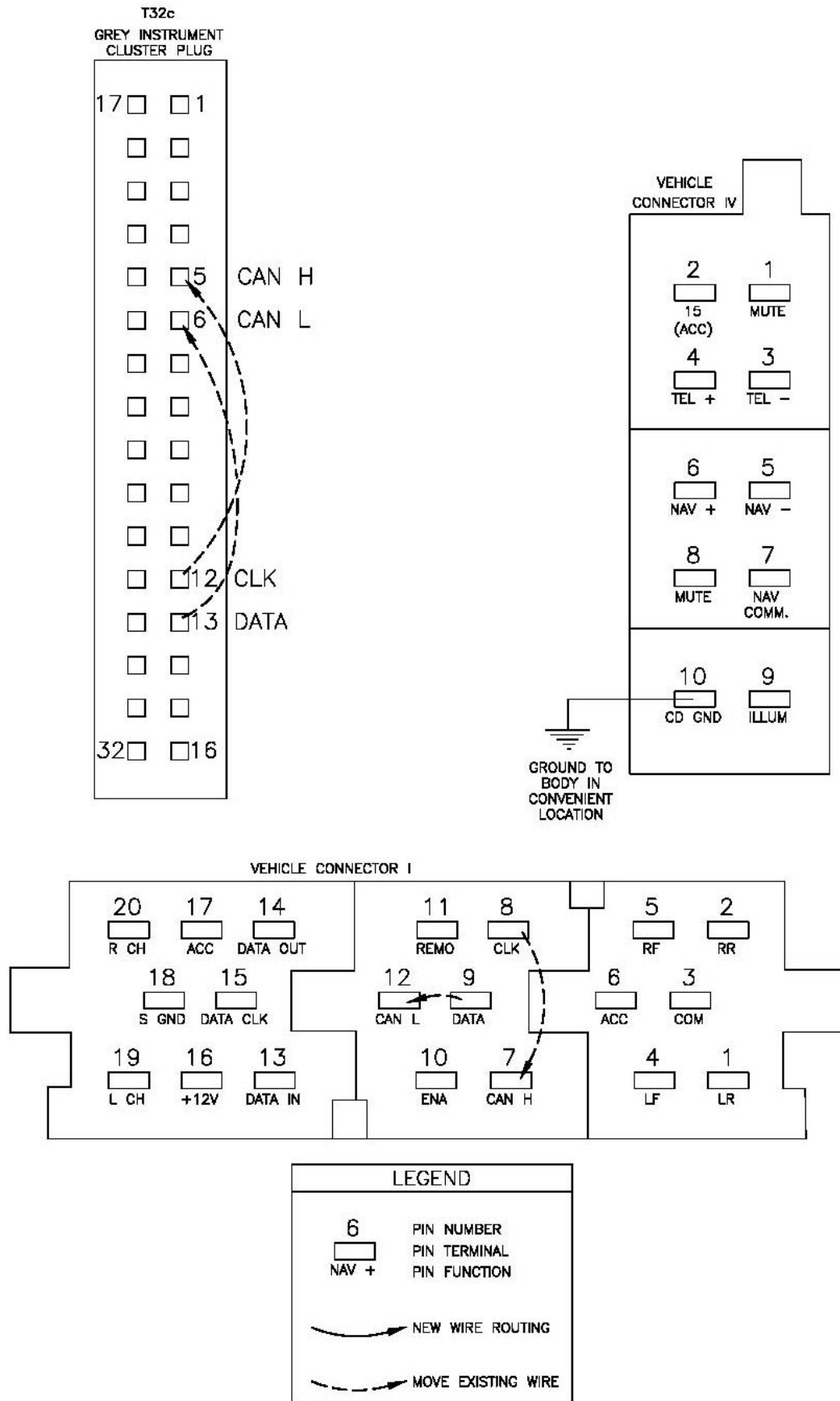

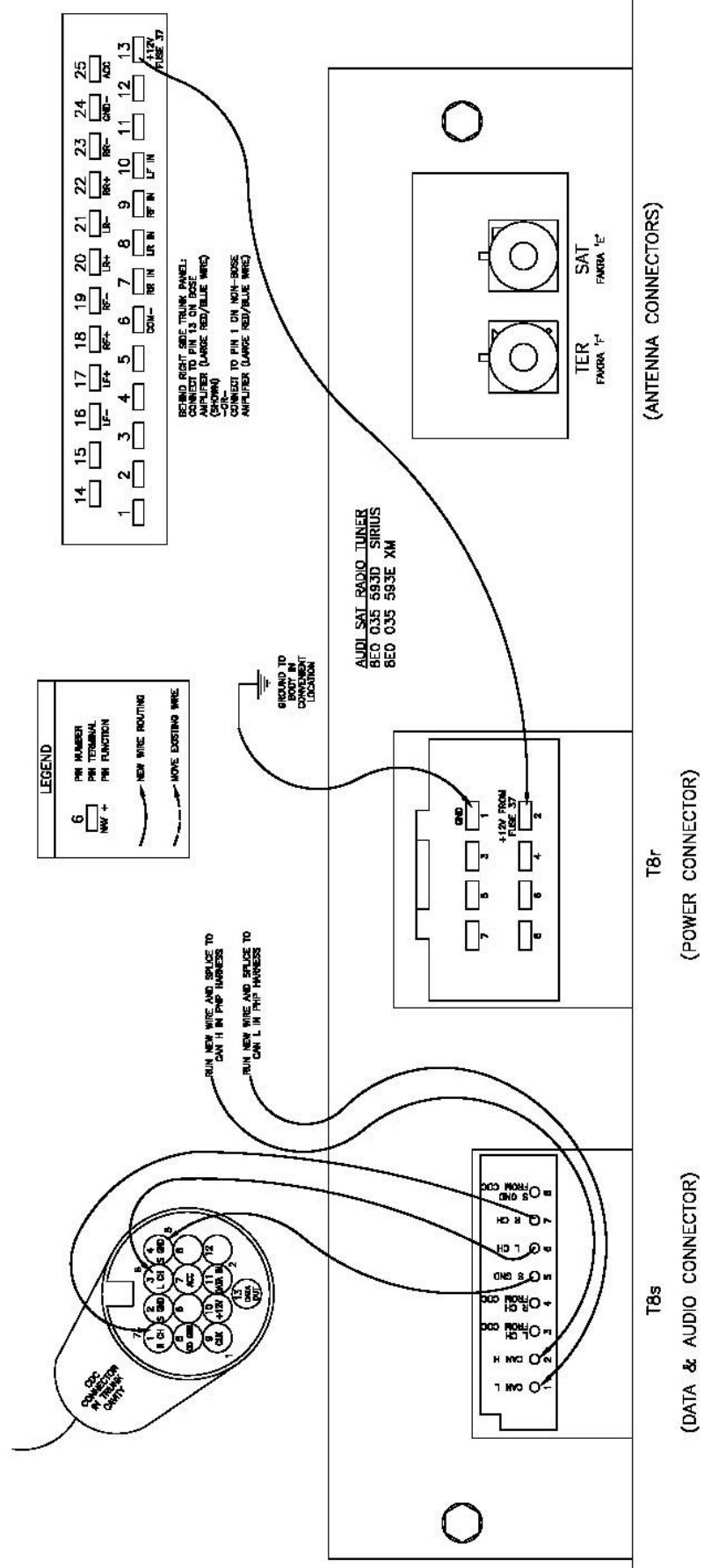

Appendix E (cont.) SAT Tuner Wiring Diagram

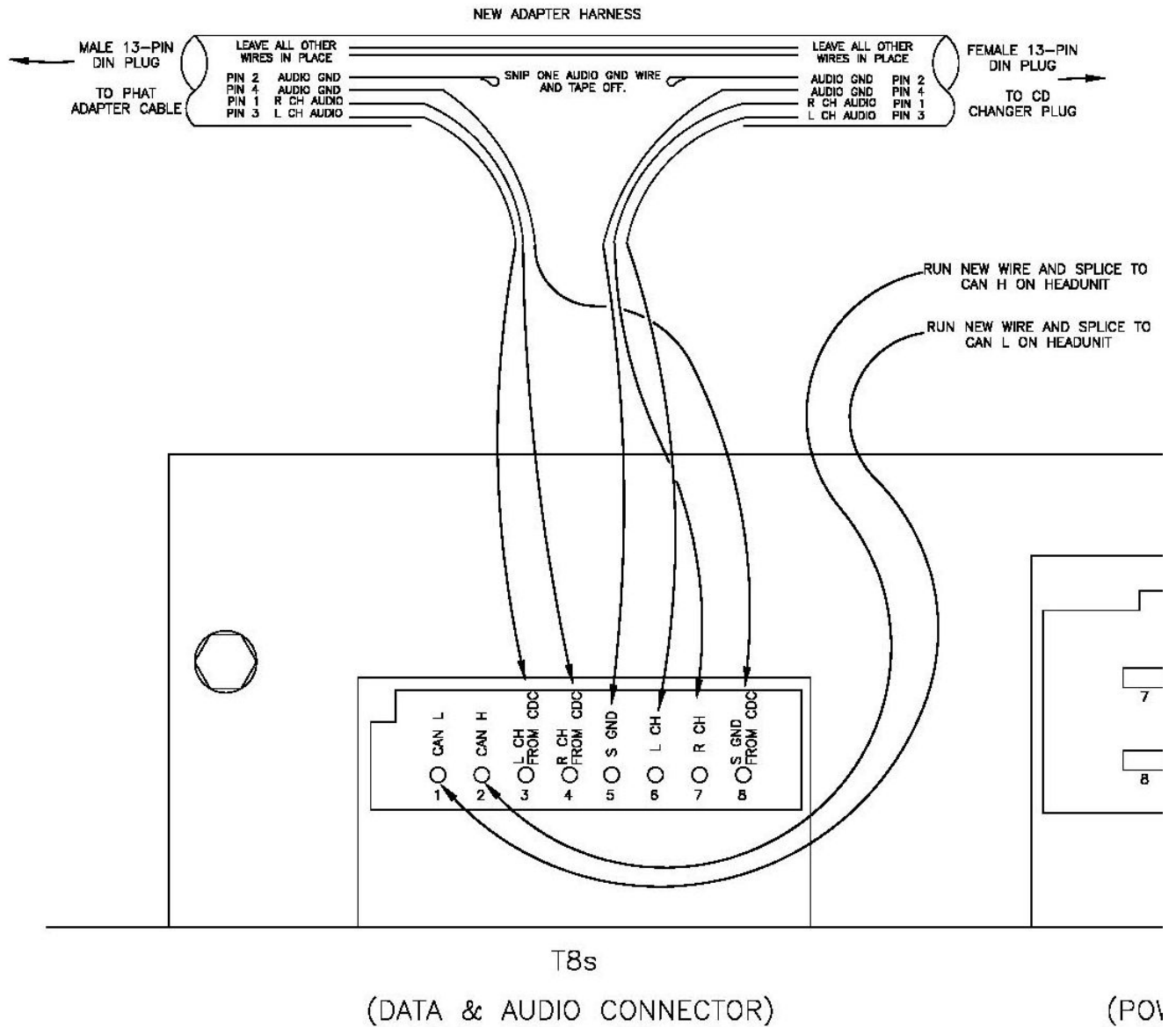

WIRING for SAT & PHAT together
for cars with CD changer harness in trunk

Appendix E (cont.) SAT Tuner Wiring Diagram

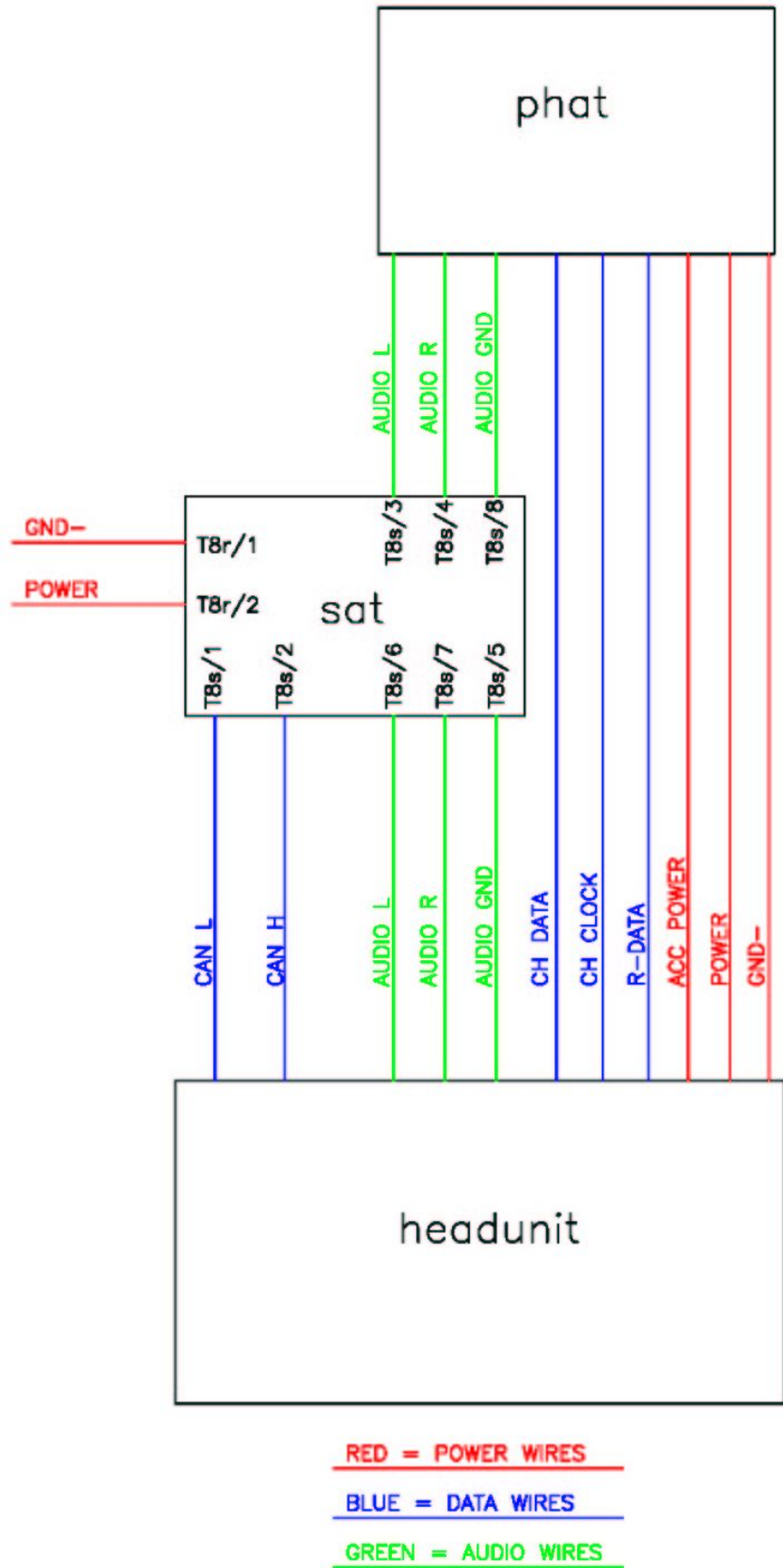

Schematic of SAT & PHAT together

Rear Cross Panel Trim

- Remove trunk light from cross panel trim -1-
- Remove screws -2- (2X)
- Remove screws -3- (4X) from fastening rings -4- on left and right.
- Unclip rear cross panel trim -1- upward.
- Guide trunk light through opening.
- After installing make sure seal is correctly seated.

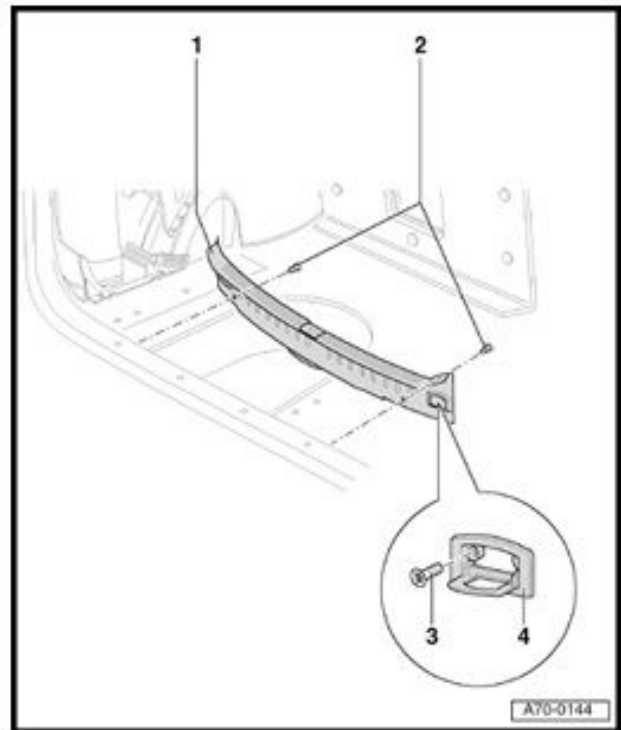

Luggage compartment side trim

- Remove luggage compartment floor covering.
- Remove rear cross panel trim.
- Remove screws -6- (2X) for fastening rings -7-.
- Unclip clip -3-.
- Unfasten clip -4-.
- Unclip clip -2-.
- Unclip luggage compartment trim -1- at rear from mounts -5- (3X).
- Pull trim forward to disengage from latch pin.

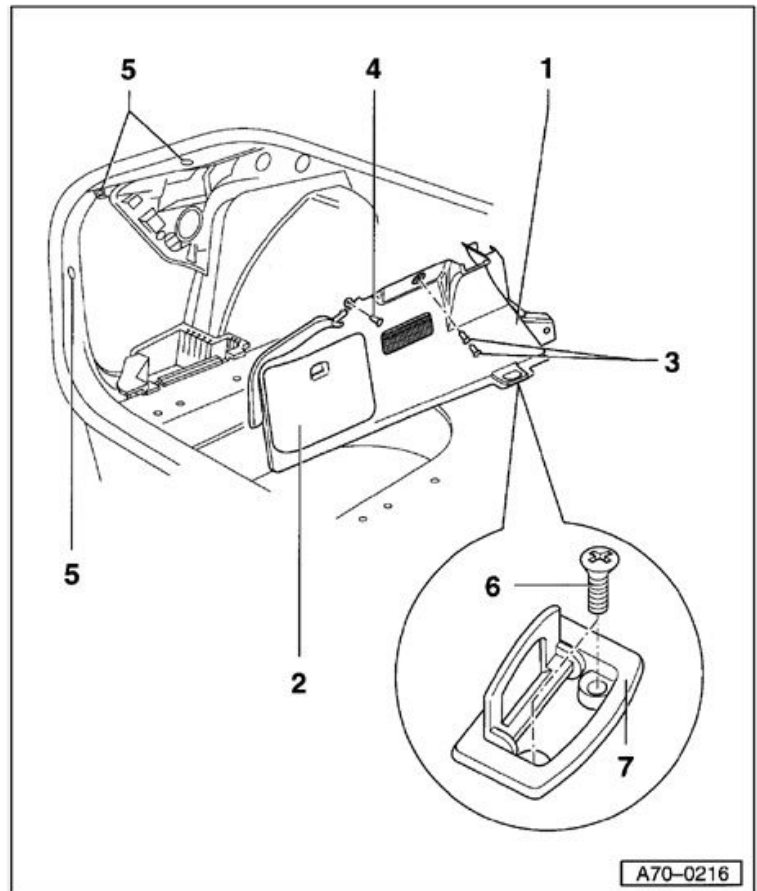

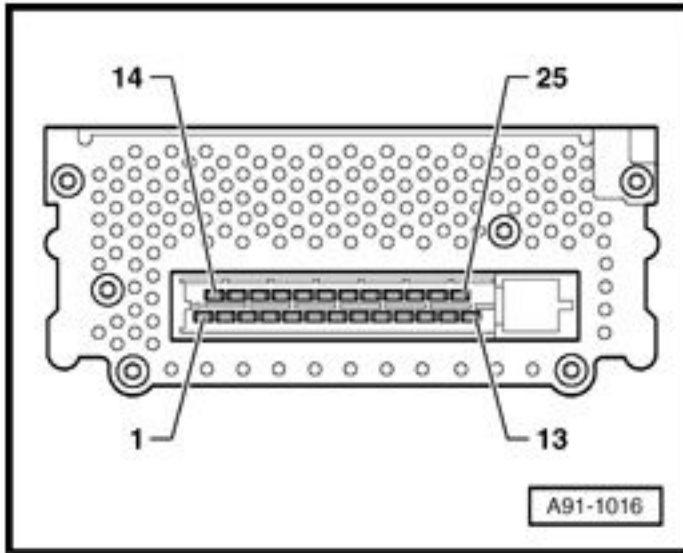

- 6 – Line Output – GND (from headunit)
- 7 – Line Output – Right Rear (from headunit)
- 8 – Line Output – Left Rear (from headunit)
- 9 – Line Output – Right Front (from headunit)
- 10 – Line Output – Left Front (from headunit)
- 13 – Battery B+ (terminal 30)
- 16 – Loudspeaker (-) Left Front
- 17 – Loudspeaker (+) Left Front
- 18 – Loudspeaker (+) Right Front
- 19 – Loudspeaker (-) Right Front
- 20 – Loudspeaker (+) Left Rear
- 21 – Loudspeaker (-) Left Rear
- 22 – Loudspeaker (+) Right Rear
- 23 – Loudspeaker (-) Right Rear
- 24 – Main Ground (terminal 31)
- 25 – Switched positive (from headunit)

It is the opinion of the author that the climate control faceplate does not need to be replaced when the RNS-E navigation unit is installed. The color difference is not noticeable except in flash photography or in other very bright light. Below is a picture of a 2001 faceplate in natural lighting for reference.



To replace the climate control faceplate, remove the two screws at the top corners of the climate control unit. Open the ashtray. With a small screwdriver, push the two tabs on the bottom of the unit while pushing the unit out from behind. Unplug the five wire connector housings and completely remove the unit from the car. With a small Philips screwdriver remove all screws from the rear of the unit. Remove the outer housing from the unit. Now inside the unit, remove the faceplate from the circuit board by removing all small Philips screws. Remove the “OFF” button from the faceplate by pushing it out from the back.

Remove the newer faceplate from the new climate control unit. Some newer A6 climate controls are built with small Torx screws instead of Philips head screws. Once the new faceplate is free from the circuit board, remove the auto-recirculation button by pushing it out from the back. This is the button with the letter “A” inside the recirculation arrow. Install the original “OFF” button in its place. Install the new faceplate onto the original climate control unit. Reinstall the re-faced climate control unit into the vehicle. Installation is reverse of the removal process.



Do not install the 2002-2004 climate control unit. It will not function properly.

The RNS-E has a nice feature called Screen Shot Mode that saves the current screen image to the SD card in slot 1.

The SD card in Slot 1 must have enough free space to store the screen shots that are about 300KB each.

SD card slot 2 must be vacant.

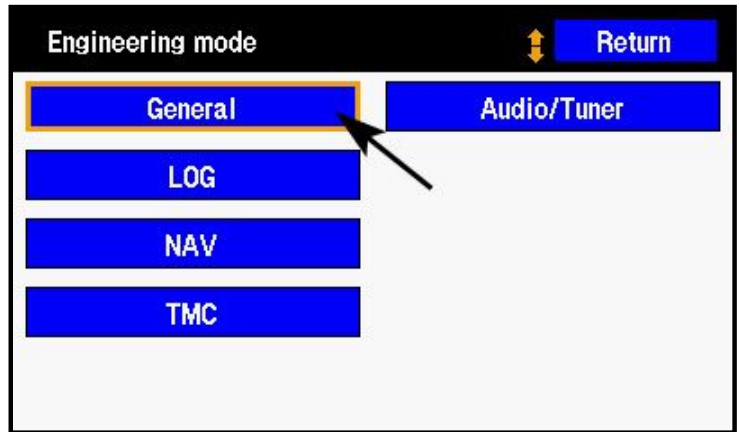

To enable Screen Shot Mode, enter Engineering Mode as described in Appendix B. Enter the General category and select “Screen shot mode”. This selection will highlight to indicate the unit is ready to save the screen images.

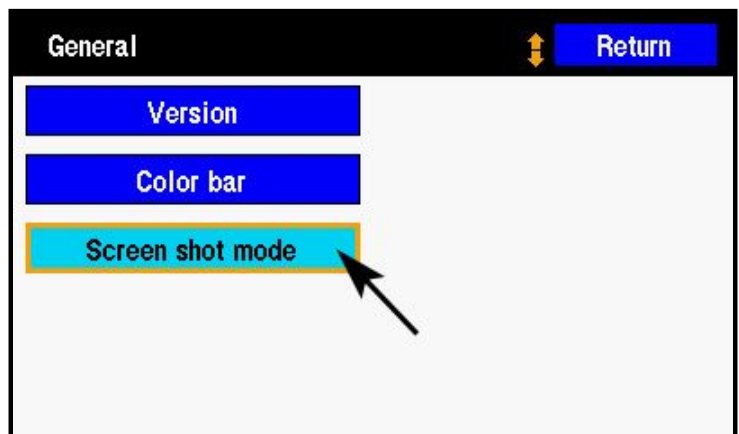

Screen shots may now be saved at any time and in any mode. To save a screen shot, press and hold the “next track” button for 5 or 6 seconds until the screen flashes black then returns to the current display.

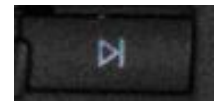

The screenshots will be saved in .bmp format in a folder named “SCR_Shot” on the SD card.

To exit screenshot mode, return to Engineering Mode and deselect the Screen shot mode menu item.

 Special thanks to S4LoneStar for originally posting this information on www.navplus.us



 Prerequisite: Multifunction steering wheel, coded for radio, telephone, and voice recognition operation.

The Basics

- Press the  button to activate voice commands. "SPEAK" is displayed in the DIS.



- Press the  button to display your telephone contacts list in the DIS.

Scroll through the contacts with the  and  buttons on the steering wheel. The contact information will alternate between the contact name and the contact phone number every few seconds. If you have multiple numbers for one contact, they will be listed as a separate entry that you can scroll to. For this reason, it is helpful to wait until the actual contact phone number is displayed to verify it is the right number you wish to dial (mobile, home, work, etc.)



- Press the  button to dial the contact currently shown in the DIS. The contact's name will be displayed in the DIS while the call is active.



- Press the  button to end the current phone call.

None of these button presses actually changes the display on the RNS-E screen unless you say "Help" while the voice commands menu is active. This will change the RNS-E screen to show a list of Telephone SDS commands that are possible. The BT lady will speak this list of possible commands to you as they are displayed on the screen.

At any time during the steering wheel activated phone call, you may press the "TEL" button on the RNS-E to enter more numbers (e.g., voicemail PIN, etc.)



Voice Recognition Operation

Once in the voice recognition mode, you may dial numbers by speaking the digits, redial the previous number, or voice dial contacts stored in the car's phonebook. This phonebook is specific to the car, and are stored in the BT module's memory. You can store up to 50 numbers in the phonebook by voice and then recall them later to voice dial.

- To dial number by digits, speak "Dial Number", and then speak each digit. The BT lady will repeat them back to you. If correct, speak "dial". The BT lady will confirm by saying "the number is being dialed".
- To redial the previous number, speak "Redial". The BT lady will confirm by saying "the number is being dialed".
- To store a number for voice dialing, speak "Store Name". The BT lady will guide you through the correct actions. You speak the name twice then speak the digits to be stored. This is very similar to the older cell phone voice dialing tags that you had to manually store. If successful, the voice tag will be saved to the BT module phonebook.
- To hear your phonebook, speak "Phonebook". The phonebook name entries will be played in sequence to remind you what you have stored.
- To voice dial an entry in your BT module phonebook, speak "Name". The BT lady will confirm by saying "Say the Name". Speak the name exactly as you have stored it in your BT phonebook. The BT module will repeat the entry for confirmation. Speak "Dial" and the BT lady will confirm by saying "the number is being dialed".

Other Notes

- At any time during a call, the  button may be pressed to end the call, no matter how it was originated (steering wheel, voice, or RNS-E entry).
- The contact name for the active phone call is displayed in the DIS if that number is stored in your phone's contact list, no matter how the call was originated (steering wheel, RNS-E buttons, or received call).
- If you have an entry in your phone's contact list for your voicemail number that includes pause characters and PIN, these will be dialed correctly if the call is originated using the steering wheel buttons (R/T, up/down scroll, phone icon).